



# 3674 Series Vector Network Analyzer



**Ceyear Technologies Co., Ltd.**

## Product Overview

Ceyear 3674 Series vector network analyzer is the peak of technological innovation, which can easily deal with the severe challenges brought by semiconductor chip testing, material testing, antenna testing, high-speed cable testing, and microwave component testing and so on. Excellent RF characteristics, flexible hardware configuration and rich software functions complement each other; only one connection can be completed in a variety of measurement tasks. Innovative human-computer interaction design can help you complete the required measurement Settings quickly and conveniently, and the large touch screen brings you a flexible and efficient operation experience.

## Main Features

- 500Hz~110GHz broad band coaxial coverage
- 30 MHz IF bandwidth, measurement points 200001
- Ultra-fast scanning speed, 140dB large dynamic range
- It has 21 functions, such as pulse S-parameter measurement, frequency Conversion device measurement, gain compression measurement, noise coefficient measurement, frequency spectrum measurement, signal integrity measurement, total harmonic distortion measurement, active intermodulation distortion measurement, and automatic fixture removal
- SCPI instruction synchronization record, script generated with one key
- A 15.6-inch multi-parameter display on the same screen, with multi-touch operation

# Ultra Wide Band Vector Network Analyzer

## From 500 Hz to 110 GHz for coaxial coverage

Ultra-wide frequency coverage, which low frequency expansion to 500Hz, and the highest test frequency up to 110GHz.

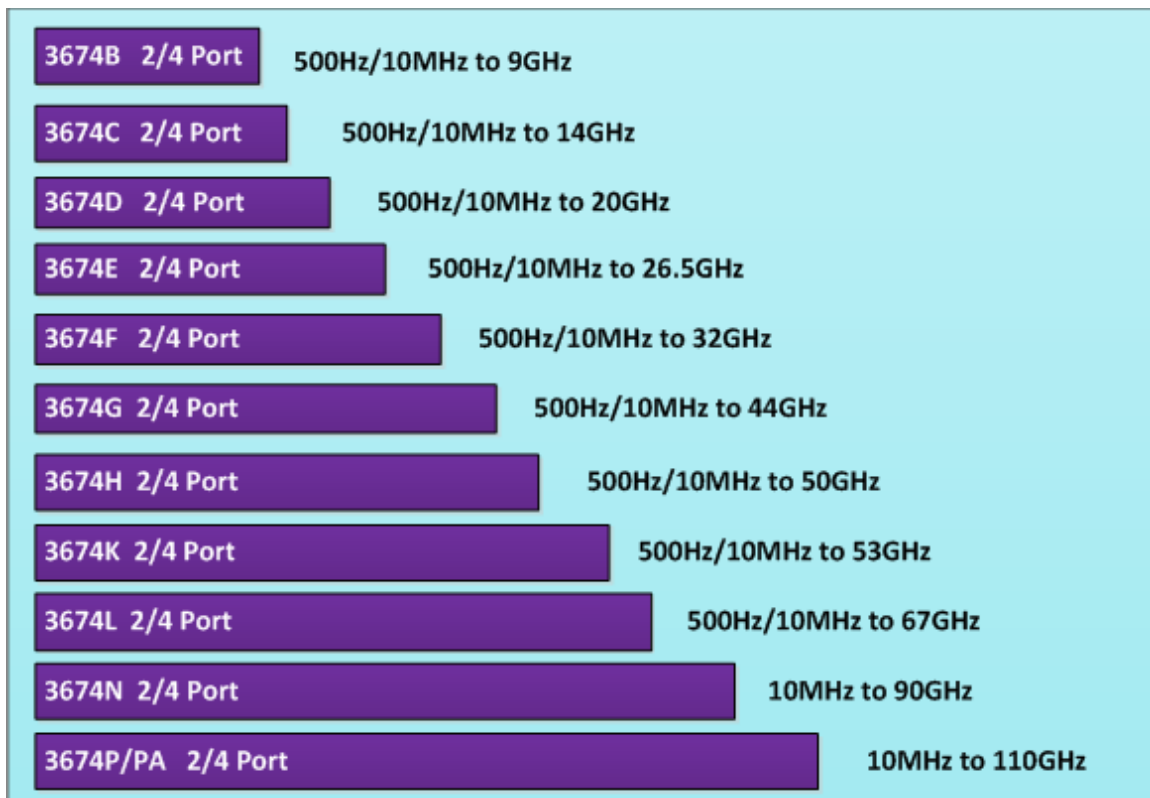

## Excellent performance

- Faster measurement speed, improve the production efficiency
- Higher measurement accuracy, to meet the measurement requirements of higher specification products
- Up to 30 MHz IF bandwidth, can achieve fast test and narrow pulse test
- The maximum number of 200001 measurement points can bring more refined measurement results
- Using ultra-wide band base wave mixing technology and source output power improvement technology, we greatly improve the dynamic range, and the optimal dynamic range can reach 140dB, providing more accurate and reliable measurement results for the test of large dynamic devices such as filters

## Rich Features

With pulse S-parameter measurement, frequency conversion device measurement, gain compression measurement, noise coefficient measurement, spectrum measurement, signal integrity measurement, total harmonic distortion measurement, active intermodulation distortion measurement, automatic fixture removal of 21 kinds of function, combined with the specific application form system level test solution, accurate joint user needs of different industries.



# Pulse S-parameter Measurement

## Built-in pulse modulation, the test is fast and simple

Built-in 4-way pulse generator for internal source modulation, IF gate control, and output from the rear panel, The pulse width and time delay of each pulse generator can be set independently.

Source modulation sources include multiple states such as rear panel input, internal pulse generator, normally open and normally closed. The source of the vector network analyzer can be modulated by external pulses or modulated by an external modulator and measured by triggering the synchronization mode. The pulse S parameter measurement function provides strong support for the test of radar T / R components and antenna signal and transceiver module.

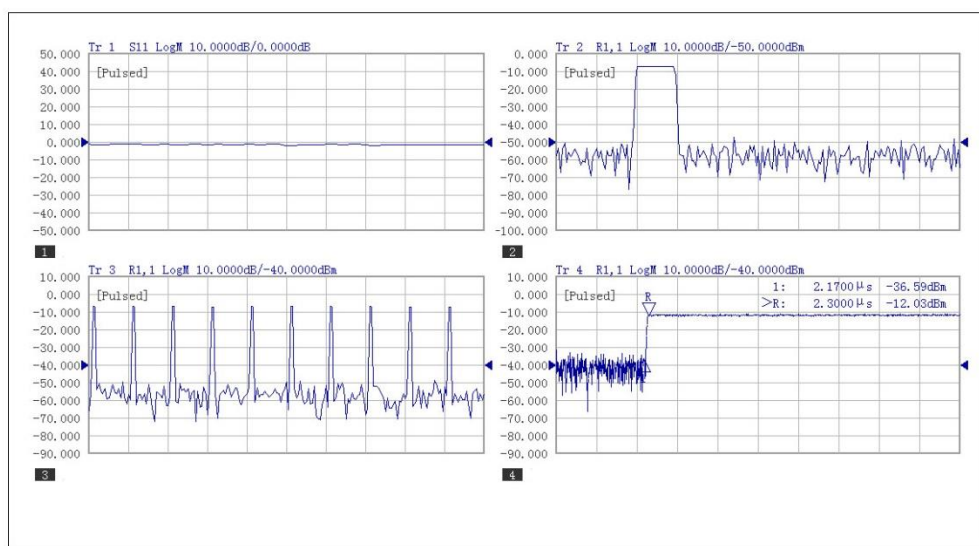

**Pulse SetupChannel1**

<b>Basic Setting</b>		<b>Profile</b>																															
OFF <input type="radio"/>	PRI 1.000000000000 ms	Autoselect Profile Time <input checked="" type="checkbox"/>																															
Pulse Measurement <input type="radio"/>	PRF 1.000000 kHz	Start 0.000 ps																															
Profile <input checked="" type="radio"/>	Width 100.0000000000 μs	Stop 200.0000000000 μs																															
Source Mod Pulse1 ▼	Main Delay 0.000 ps	<b>Detection Method</b>																															
<b>Options</b>		Auto <input checked="" type="radio"/>																															
Autoselect Source <input checked="" type="checkbox"/>	Enable Optimize PRF <input type="checkbox"/>	Narrowband <input type="radio"/>																															
Autoselect Width&Delay <input checked="" type="checkbox"/>	Auto Set IF Gain <input checked="" type="checkbox"/>	Wideband <input type="radio"/>																															
IFBW 15 kHz																																	
<table border="1" style="width: 100%; border-collapse: collapse; text-align: center;"> <thead> <tr> <th>Name</th> <th>Source</th> <th>Width</th> <th>Delay</th> <th>Atten</th> </tr> </thead> <tbody> <tr> <td>A</td> <td>Pulse0 ▼</td> <td>8.333 ns</td> <td>20.000 μs</td> <td>0</td> </tr> <tr> <td>B</td> <td>Pulse0 ▼</td> <td>8.333 ns</td> <td>20.000 μs</td> <td>0</td> </tr> <tr> <td>C</td> <td>Pulse0 ▼</td> <td>8.333 ns</td> <td>20.000 μs</td> <td>0</td> </tr> <tr> <td>D</td> <td>Pulse0 ▼</td> <td>8.333 ns</td> <td>20.000 μs</td> <td>0</td> </tr> <tr> <td>R</td> <td>Pulse0 ▼</td> <td>8.333 ns</td> <td>20.000 μs</td> <td>0</td> </tr> </tbody> </table>				Name	Source	Width	Delay	Atten	A	Pulse0 ▼	8.333 ns	20.000 μs	0	B	Pulse0 ▼	8.333 ns	20.000 μs	0	C	Pulse0 ▼	8.333 ns	20.000 μs	0	D	Pulse0 ▼	8.333 ns	20.000 μs	0	R	Pulse0 ▼	8.333 ns	20.000 μs	0
Name	Source	Width	Delay	Atten																													
A	Pulse0 ▼	8.333 ns	20.000 μs	0																													
B	Pulse0 ▼	8.333 ns	20.000 μs	0																													
C	Pulse0 ▼	8.333 ns	20.000 μs	0																													
D	Pulse0 ▼	8.333 ns	20.000 μs	0																													
R	Pulse0 ▼	8.333 ns	20.000 μs	0																													
Pulse Generators...		Pulse Trigger...																															
Apply		OK																															
		Cancel																															

## Excellent pulse test capability

- Pulse period of up to 70s
- The pulse resolution was as low as 8.3ns
- Broadband synchronous pulse test pulse width <42ns
- Internal pulse synchronization or external pulse synchronization mode
- 7 source modulation modes, such as external and internal pulses
- 4 pulse generators with pulse width and independent delay
- Automatic broadband synchronous measurement and narrow-band asynchronous measurement function
- Adaptive narrow-band filter to improve the narrow-pulse test capability
- 3 for triggering input and output modules to provide flexible system coordination function
- Functions of sweeping pulse S parameter test, pulse envelope test and pulse point test

# Mixer/Converter Scalar Measurement

## Comprehensive Mixer/Converter Characteristic measurement

Provide comprehensive measurement setting of Mixer/Converter characteristics, support double-order primary vibration and external primary vibration source input; support multiple scanning types such as linear sweep, power sweep and segment sweep; simple setting can automatically complete the complex mixer RF, double LO, IF frequency doubling and frequency distribution; support the setting of source port power, local vibration port power, attenuation and power sweep characteristics.

## Simple and efficient frequency conversion loss amplitude response characteristic test and analysis

Provide the most direct and accurate mixer / Converter frequency conversion loss amplitude response measurement function. Enhance power calibration by power meter to complete the RF and IF full band calibration.

## Independent dual-power calibration method realizes the test and analysis of non-inserted frequency conversion device

Support dual independent source power and receiver calibration, provides the solution of non-insertion connection mode through port separation mode, instead of connector de-embedding, power meter de-embedding and other ways, to provide a more accurate calibration mode for non-insertion measured parts.

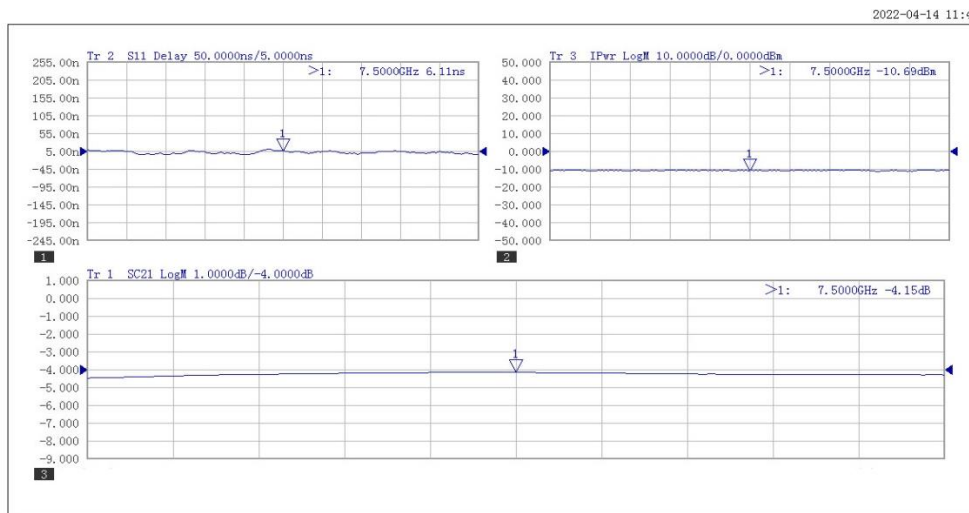

## Mixer/Converter Vector Measurement

A single instrument simultaneously completes the amplitude response and the absolute phase timely delay response test analysis

Provide complete mixer / frequency converter amplitude response, absolute phase and absolute delay response measurement ability, a single connection can complete the mixer / frequency converter complex characteristic measurement, high amplitude and phase measurement accuracy.

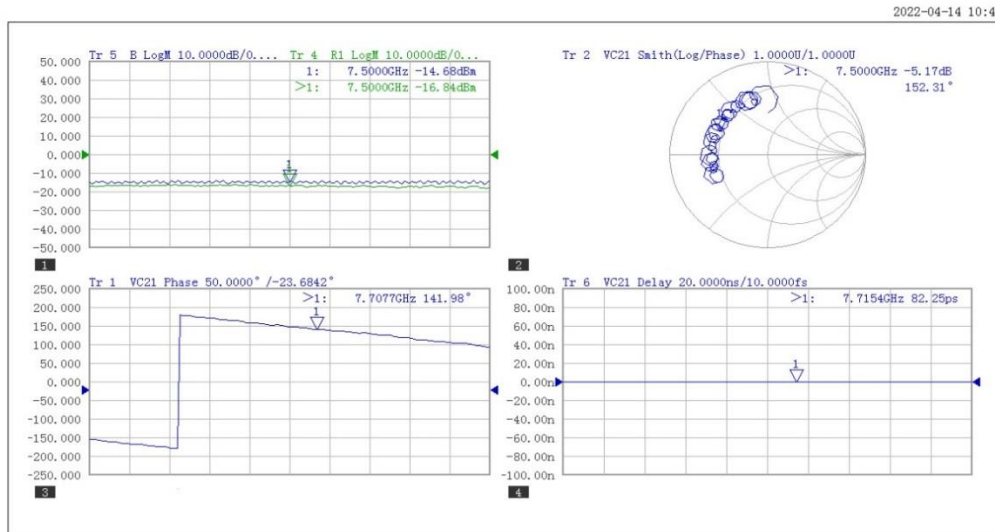

## Characterization of the mixer / Converter characteristics

The vector measurement analysis of mixer / Converter can complete the characterization of the mixer, which is used to determine the characteristics of the mixer and obtain the characteristics of the Converter.

The feature characterization function serves as an independent function, and the generated mixer characterization data files can be automatically called in the vector measurement analysis.

# Gain Compression Measurement

## Single connection, quickly complete the amplifier gain compression parameter test

The gain compression measurement function completes the measurement of the linear gain, compression point gain, input power, output power, and linear input matching in the active device through one connection and one calibration.

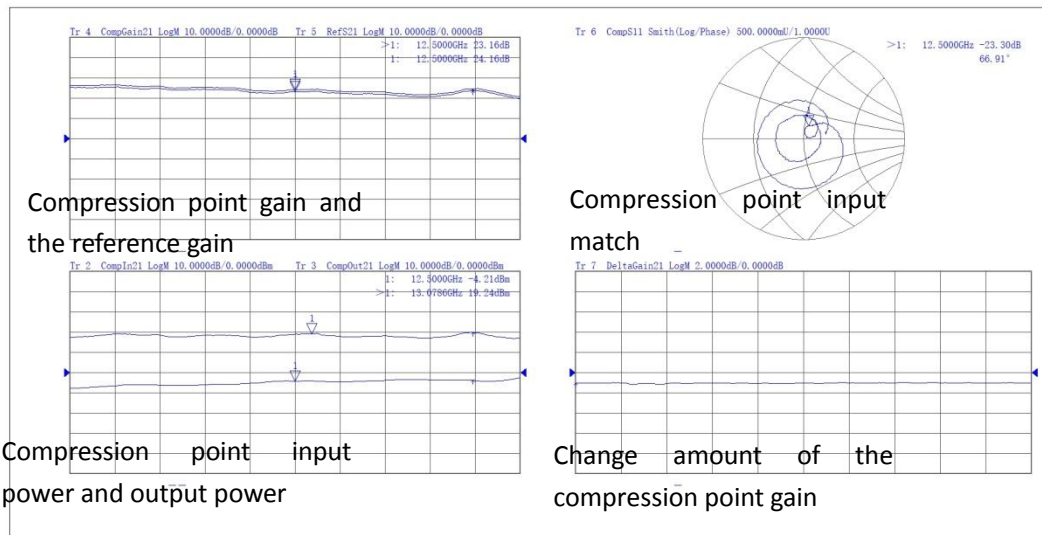

## Power calibration, guide calibration to obtain high precision measurement

Power calibration and receiver calibration can obtain accurate compression point input power and output power values. The exact gain measurement and input / output matching values can be obtained.

## Various scanning methods and compression methods should deal with different measurement scenarios

Intelligent scanning can quickly and accurately get compression points, provide the power scanning of each frequency point and the frequency scanning mode of each power point, obtain complete measurement data, provide from linear gain compression, from the maximum gain compression, from the fallback point compression, X/Y compression, saturated state compression, users can choose different compression methods according to the type of test and different measurement scenarios.

## 3D view drawing, visually show the characteristics of the tested parts

Provide 3D view function to better show the performance of the tested device under the excitation state; it can also show the frequency profile and power profile to visually show the characteristics of the measured device at each frequency point and each power point.

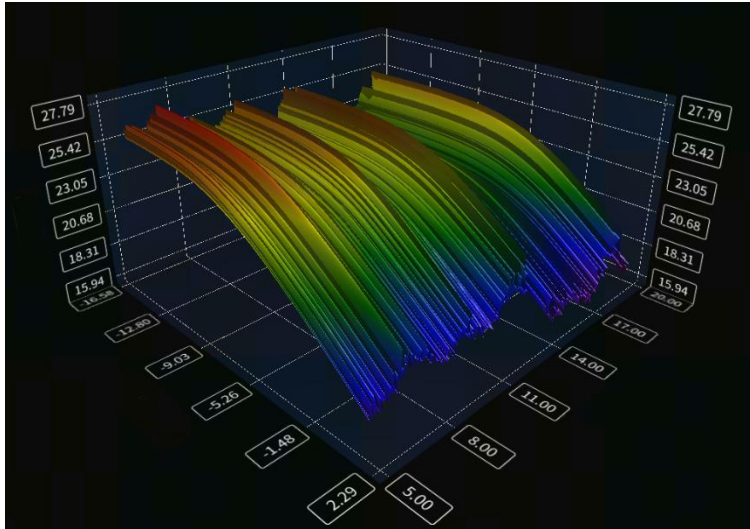

Three dimensional view

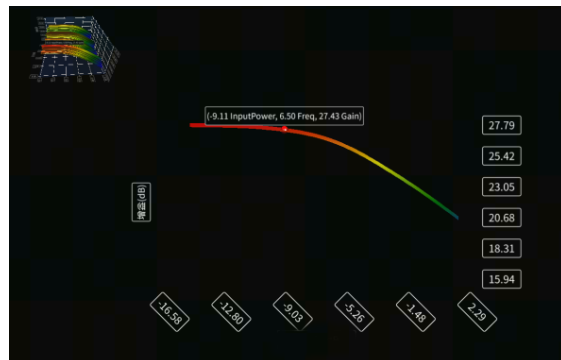
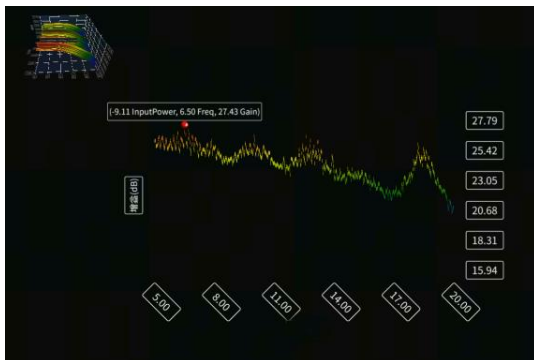

Power section, frequency section

# Noise Figure Measurement

## Fast, accurate, and large dynamic range

Primary connection can simultaneously test S parameters, noise coefficient, noise parameters, gain compression and frequency conversion gain. Based on the cold source noise coefficient test method, the accurate noise coefficient and noise parameter test can be conducted. By constructing the advanced noise correlation matrix model and combining with the precise S parameter calibration of the vector network analyzer, it is suitable for the accurate test of the measured parts with the lower noise coefficient. The measurement dynamic range can reach 55dB, which is suitable for testing of subjects with large gain.

## Analysis of the noise coefficient test of non-standard interface devices such as microwave chip

Based on the patented noise embedding / deembedding technology, the noise coefficient test of non-standard interface devices is realized. In particular, it can solve the problem of microwave chip noise coefficient in the chip test, and eliminate the impact of the mismatch between the tested parts and the test equipment.

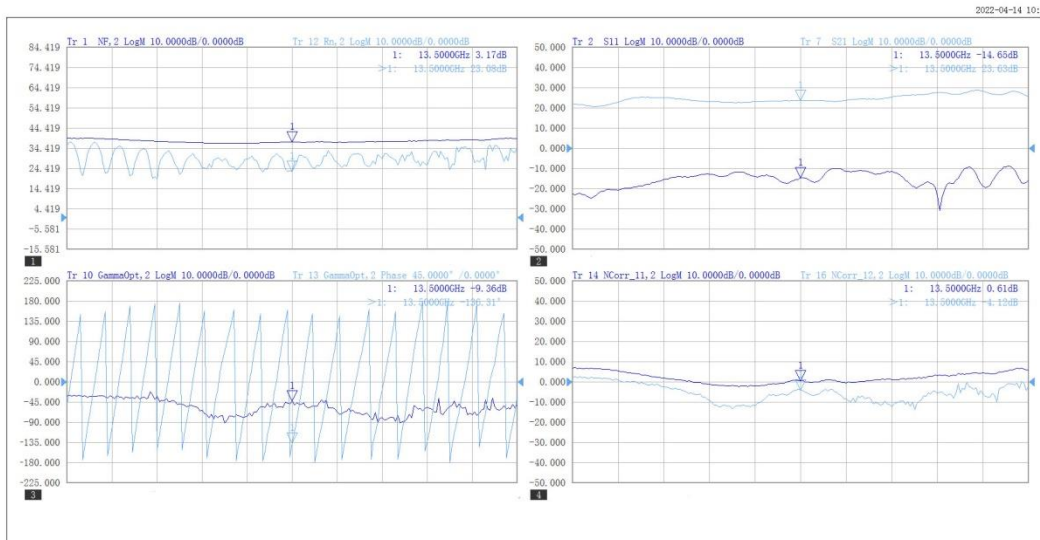

## Test and analysis of the noise parameters

The noise coefficient and the noise parameters can be tested simultaneously, including the amplitude and phase of the minimum noise coefficient, the noise internal resistance and the optimal reflection coefficient.

The influence of noise parameters can be eliminated by the modification of noise power receiver.

# Spectrum Analysis Measurement

## Rapid search of multipoint stray spectra and harmonics

Each port of the vector network analyzer can complete the measurement of the input and output spectrum of the measured signal and the spectrum measurement technology based on fast Fourier transform can quickly locate the state of the stray spectrum and harmonic of the measured spectrum at a small resolution bandwidth.

## A single connection of a single instrument completes the multi-parameter evaluation of the measured device

For the test of active devices, the spectrum measurement function can provide more measurement parameters, a single instrument can realize the conventional S parameter test, stray and harmonic positioning measurement; complete ratio and absolute measurement error correction technology can provide more accurate measurement results.

## Efficient labeling and measurement function

The marking of spectrum measurement function can provide in-band power, power spectral density, occupied bandwidth, adjacent power ratio and other indicators, and one-click setting and real-time update.

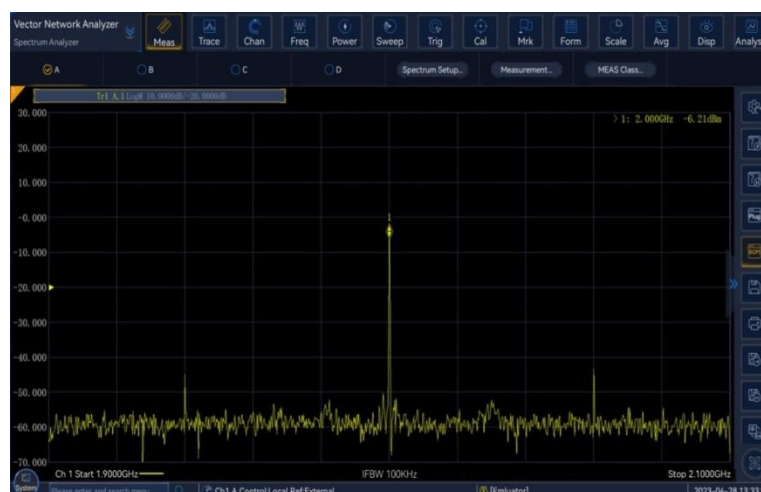
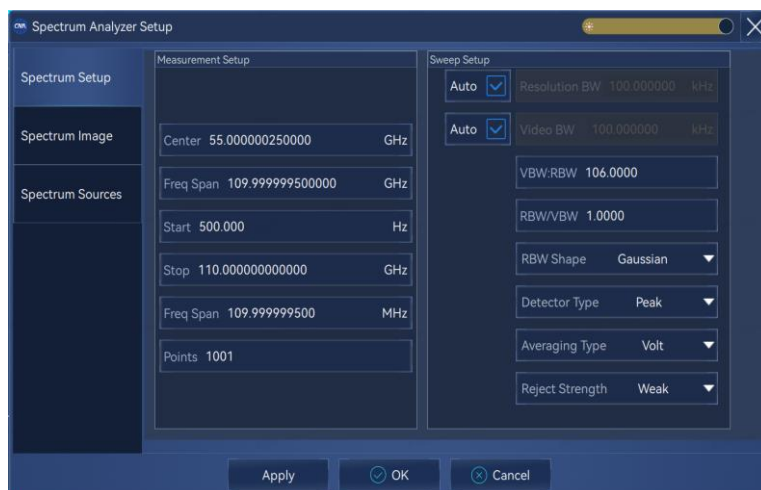

## Analysis of the signal integrity measurements

### Ultra-broadband coverage enables time-domain analysis with micron-scale resolution

Powerful signal integrity measurement and analysis ability, can provide micron level spatial resolution, for small size chip packaging test, to solve the problem of positioning discontinuity.

### Test analysis of the signal integrity in a single view

A single view completes both time domain and frequency domain test analysis, helping the user to find the source of impedance discontinuity, reflection and crosstalk. It can accurately measure the impedance characteristics of transmission lines; convenient proximal and remote crosstalk tests to test the degree of interaction between multiple transmission lines.

### Simulated eye diagram for rapid analysis of signal integrity

It has the function of virtual eye map generation and analysis based on network parameters. Depending on the different high-speed digital communication standards, high-efficiency Pass / Fail tests can be performed using pre-defined eye-map templates.

Jitter, noise and other interference can be applied to the simulated eye map, and the simulated eye map of different positions in the high-speed link can be simulated through the addition of correction algorithms such as pre-aggravation and equilibrium.

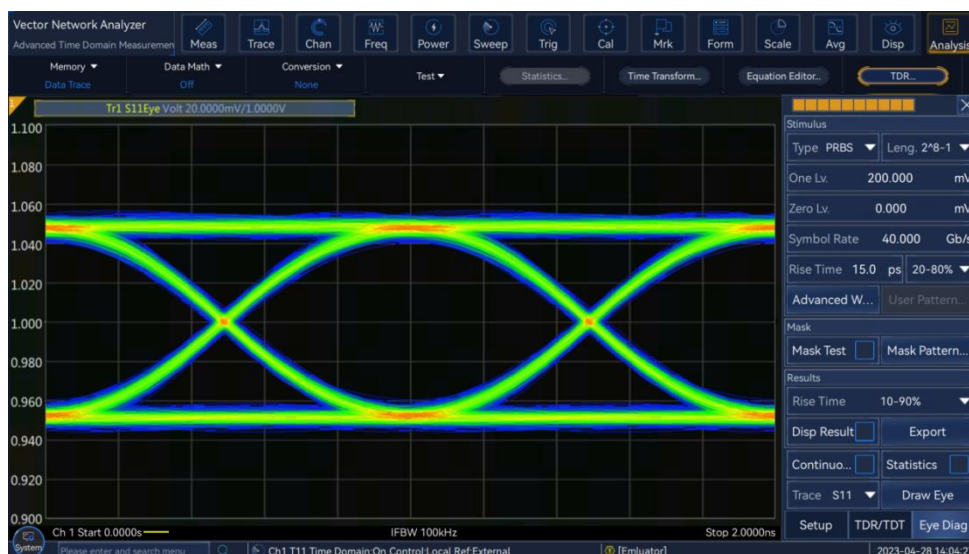

# Analysis of the total harmonic distortion (THD) measurement

## Test analysis of multiple harmonics of a wide-band coverage differential amplifier

Broadband test can be used for the measurement and analysis of input and output power, gain, harmonic total distortion and other parameters under true differential excitation, and simplify the harmonic performance test complexity of differential active devices with as amplifier.

## Single calibration simultaneously completes the multi-channel error correction

A single calibration can simultaneously complete the multi-channel error correction of the standard S parameter and the total harmonic distortion, that is, the ratio measurement error, the absolute receiver measurement error, and the error correction of the port excitation power. The transmission and mismatch errors introduced by different mechanical attenuation files between the channels can also be compensated by a single calibration.

## Convenient and efficient setting mode of measurement parameters

The editing of setting the measurement parameters can be completed by XML file. The parameters can be imported with one key, and the imported measurement parameters can be updated to the parameter selection interface in real time.

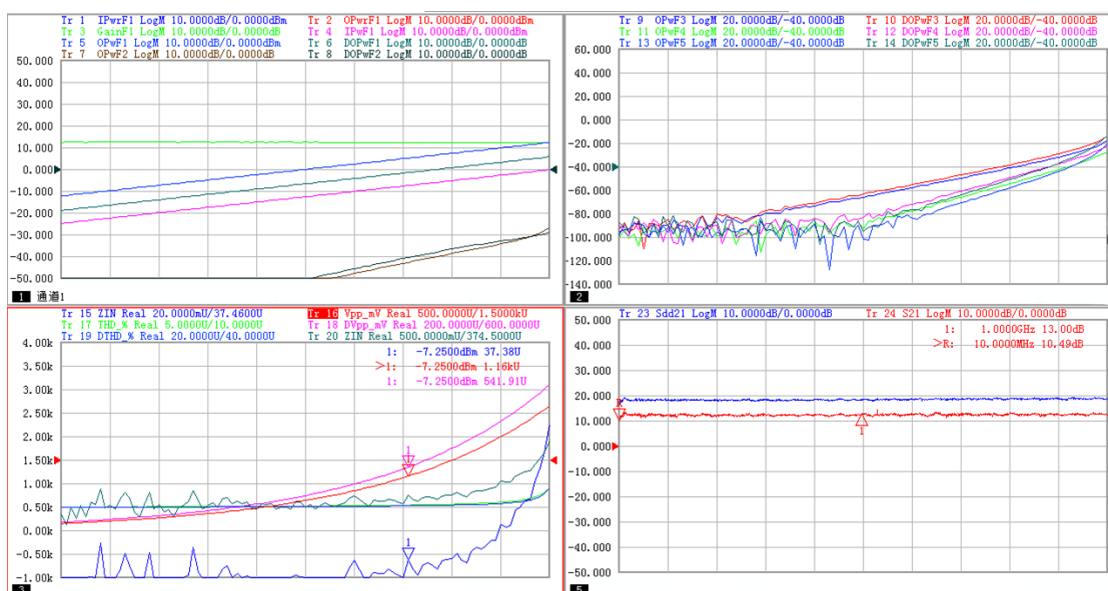

# Automatic Fixture Removal

## Solve the test problem of non-standard joint devices

For non-standard connector devices testing, such as packaging microwave devices, in-chip devices, such devices cannot be directly connected to the vector network analyzer. The fixture is usually used to connect the measured piece to a vector network analyzer, but the fixture also introduces measurement error. The automatic fixture removal function can extract, store the fixture parameters and embed the fixture, and finally obtain the real parameters of the measured parts.

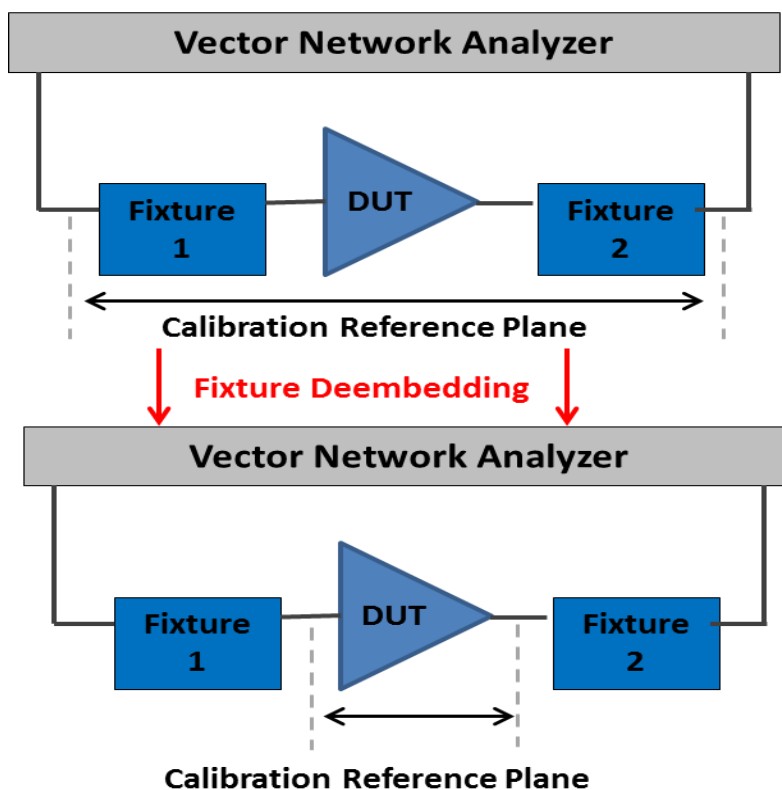

## Simple operation and high error correction accuracy

Automatic fixture removal function has the advantages of easy operation and high precision. This feature does not require custom calibration, eliminates proximal and distal crosstalk of the differential fixture, and is suitable for test scenarios with open circuit at one end of the fixture.

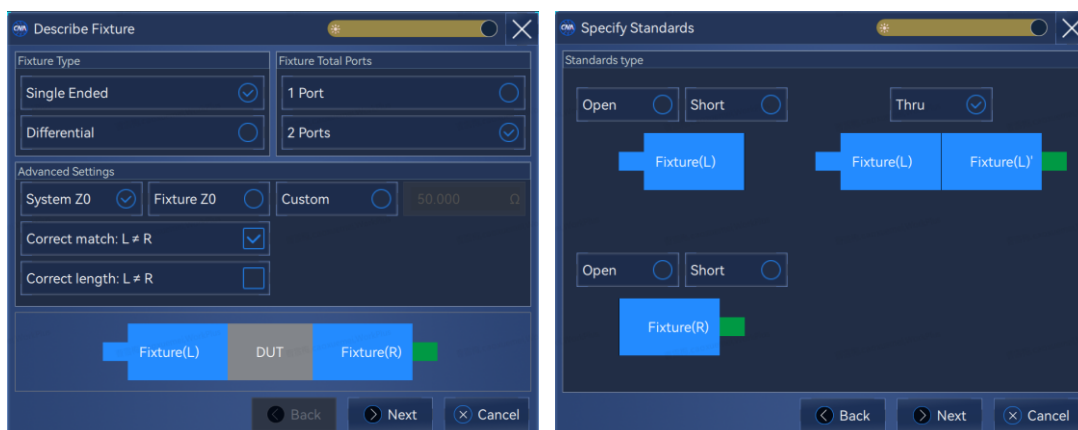

Using the automatic fixture removal function, the measured parts as a whole, balance parameter extraction and four-port embedding. It can effectively remove the transmission parameters, proximal crosstalk, and remote crosstalk.

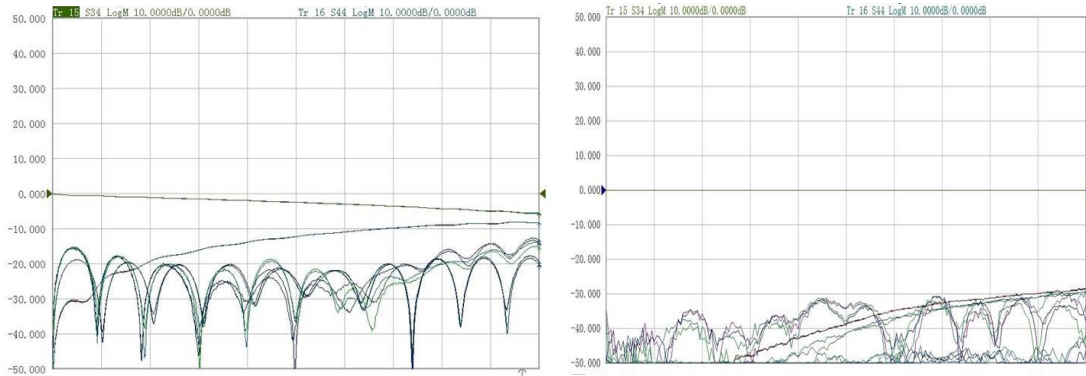

Before the fixture is embedded

After the fixture is embedded

## The Ultimate User Experience

The interface is simple and intuitive, easy to operate, and improve the test efficiency

**15.6-inch HD screen**  
2K resolution  
Multi-touch control

Personalize the display area. Hundreds of measurement windows can be displayed

Toolbar has many common functions, convenient and quick operation

The SPC1 command is recording Dedicated to automatic testing and development, save 30% workload

search function: quick location of strange functions  
Realize convenient interaction

Two / 4 ports are optional  
Flexible configuration test device

Simple interface  
stick out a mile  
The USB 3.0 interface burst transmission

## Rich in peripheral interfaces, flexible and practical



1-10 MHz external reference input / output interface

2-110V / 220V adaptive power supply input

3-Detachable CPU module, configured with hard disk, LAN, DP, USB, and GPIB Interfaces

4-excitation output and local vibration output provide flexible measurement Configuration

5-External and intermediate frequency input interface, pulse input and output Interface

6-Bias-Tee configuration input interface

7-Automatic test interface, trigger input / output interface, noise source power Interface

# Technical Specifications

## 3674B/C/D/E Technical Specifications

Frequency Characteristic		
Frequency Range	10MHz to 9 GHz /14 GHz /20 GHz /26.5 GHz	
Frequency Resolution	0.1Hz	
Frequency Accuracy	$\pm 1 \times 10^{-7} (23^{\circ}\text{C} \pm 3^{\circ}\text{C})$	
Harmonics		Typical
Port 1,3 Harmonics	-48dBc(0.01 ~ 4GHz)	-62dBc(0.01 ~ 4GHz)
	-57dBc(4 ~ 14GHz)	-68dBc(4 ~ 14GHz)
	-57dBc(14 ~ 26.5GHz)	-70dBc(14 ~ 26.5GHz)
Port 2,4 Harmonics	-13dBc(0.01 ~ 4GHz)	-24dBc(0.01 ~ 4GHz)
	-18dBc(4 ~ 14GHz)	-30dBc(4 ~ 14GHz)
	-18dBc(14 ~ 26.5GHz)	-36dBc(14 ~ 26.5GHz)
Port Power Characteristics		Typical
Power Sweep Range	33dB (10 ~ 50MHz)	36dB (10 ~ 50MHz)
	35dB (0.05 ~ 4GHz)	39dB (0.05 ~ 4GHz)
	38dB (4 ~ 16GHz)	41dB (4 ~ 16GHz)
	35dB (16 ~ 20GHz)	40dB (16 ~ 20GHz)
	32dB (20 ~ 24GHz)	39dB (20 ~ 24GHz)
	27dB (24 ~ 26.5GHz)	38dB (24 ~ 26.5GHz)
Maximum Leveled Power (Standard Configuration, Option 400)	+13dBm (10MHz ~ 50MHz)	+16dBm(10MHz ~ 50MHz)
	+13dBm (0.05GHz ~ 14GHz)	+15dBm(0.05GHz ~ 14GHz)
	+13dBm (14GHz ~ 20GHz)	+15dBm(14GHz ~ 20GHz)
	+10dBm (14GHz ~ 20GHz)	+14dBm(20GHz ~ 26.5GHz)
	+10dBm	

	(20GHz ~ 26.5GHz)	
<b>Maximum Leveled Power</b> (400+401+402+404+003 Option)	+10dBm(10MHz ~ 50MHz) +7dBm(0.05GHz ~ 14GHz) +5dBm(14GHz ~ 20GHz) +3dBm(20GHz ~ 26.5GHz)	+12dBm(10MHz ~ 50MHz) +10dBm(0.05GHz ~ 14GHz) +10dBm(14GHz ~ 20GHz) +7dBm(20GHz ~ 26.5GHz)
<b>Pulse Characteristic</b>		<b>Typical</b>
<b>Pulse Period</b>	33ns ~ 70s	20ns ~ 70s
<b>Pulse ON/OFF Ratio</b>	64dB (0.01 ~ 4GHz) 80dB (4 ~ 26.5GHz)	
<b>Network Parameter Characteristic</b>		<b>Typical</b>
<b>System Dynamic Range</b> (Standard Configuration, Option 400)	96dB(10MHz ~ 50MHz) 110dB(50MHz ~ 500MHz) 130dB(0.5GHz ~ 4GHz) 133dB(4MHz ~ 14GHz) 131dB(14MHz ~ 20GHz) 125dB(20MHz ~ 26.5GHz)	108dB(10MHz ~ 50MHz) 124dB(50MHz ~ 500MHz) 140dB(0.5GHz ~ 4GHz) 140dB(4GHz ~ 14GHz) 133dB(14GHz ~ 20GHz) 128dB(20GHz ~ 26.5GHz)
<b>System Dynamic Range</b> (400+401+402+404+003 Option)	96dB(10MHz ~ 50MHz) 110dB(50MHz ~ 500MHz) 120dB(0.5GHz ~ 4GHz) 120dB(4GHz ~ 14GHz) 115dB(14GHz ~ 20GHz) 115dB(20GHz ~ 26.5GHz)	105dB(10MHz ~ 50MHz) 120dB(50MHz ~ 500MHz) 134dB(0.5GHz ~ 4GHz) 134dB(4GHz ~ 14GHz) 128dB(14GHz ~ 20GHz) 122dB(20GHz ~ 26.5GHz)
<b>Directivity</b>	48dB (0.01 ~ 2GHz) 44dB (2 ~ 26.5GHz)	65dB (0.01 ~ 2GHz) 52dB (2 ~ 26.5GHz)
<b>Source Match</b>	40dB (0.01 ~ 2GHz) 31dB (2 ~ 26.5GHz)	46dB (0.01 ~ 2GHz) 36dB (2 ~ 26.5GHz)
<b>Load Match</b>	47dB (0.01 ~ 2GHz)	61dB (0.01 ~ 2GHz)

	44dB (2 ~ 26.5GHz)	56dB (2 ~ 26.5GHz)
<b>Reflection Tracking</b>	±0.0150dB (0.01 ~ 2GHz) ±0.0161dB (2 ~ 26.5GHz)	±0.0060dB (0.01 ~ 2GHz) ±0.0030dB (2 ~ 26.5GHz)
<b>Transmission Tracking</b>	±0.044dB (10 ~ 50MHz) ±0.055dB (0.05 ~ 2GHz) ±0.120dB (2 ~ 9GHz) ±0.110dB (9 ~ 14GHz) ±0.120dB (14 ~ 26.5GHz)	±0.001dB (10 ~ 50MHz) ±0.002dB (0.05 ~ 2GHz) ±0.004dB (2 ~ 9GHz) ±0.005dB (9 ~ 14GHz) ±0.008dB (14 ~ 26.5GHz)
<b>Others</b>	<b>Typical</b>	
<b>Trace Noise Magnitude</b> dB rms (1 kHz IF bandwidth)	0.0070(10 ~ 100MHz) 0.0020(100 ~ 500MHz) 0.0020(0.5 ~ 1GHz) 0.0020(1 ~ 14GHz) 0.0020(14 ~ 22.5GHz) 0.0030(22.5 ~ 24GHz) 0.0050(24 ~ 26.5GHz)	0.0026(10 ~ 100MHz) 0.0017(100 ~ 500MHz) 0.0006(0.5 ~ 1GHz) 0.0006(1 ~ 14GHz) 0.0007(14 ~ 22.5GHz) 0.0008(22.5 ~ 24GHz) 0.0007(24 ~ 26.5GHz)
<b>Trace Noise Phase</b> Deg rms (1 kHz IF bandwidth)	0.051(10 ~ 100MHz) 0.015(100 ~ 500MHz) 0.015(0.5 ~ 1GHz) 0.015(1 ~ 14GHz) 0.042(14 ~ 22.5GHz) 0.054(22.5 ~ 24GHz) 0.054(24 ~ 26.5GHz)	0.030(10 ~ 100MHz) 0.012(100 ~ 500MHz) 0.004(0.5 ~ 1GHz) 0.004(1 ~ 14GHz) 0.005(14 ~ 22.5GHz) 0.005(22.5 ~ 24GHz) 0.005(24 ~ 26.5GHz)
<b>IF Bandwidth</b>	1Hz ~ 30MHz	
<b>Display resolution Magnitude</b>	0.001dB/div	
<b>Display Resolution Phase</b>	0.001°/div	
<b>General Characteristic</b>		

<b>Port Connectors</b>	3.5mm (head), system impedance 50 ohms
<b>Number of Measured Ports</b>	3674B / C / D / E standard: 2-port; 3674B / C / D / E-400 option: 4- port
<b>Peripheral Interface</b>	GPIB interface, USB interface, DP interface, LAN interface
<b>Display</b>	A 15.6-inch high-resolution touch display
<b>Dimensions</b>	Overall dimensions (width and depth, including handles, feet and pads):  2- port: 475mm *279mm* 560mm  4-port: 475mm *279mm* 660mm
<b>Max. Power Consumption</b>	500W
<b>Power Supply</b>	50Hz single-phase 220V or 50Hz / 60Hz single-phase 110V AC
<b>Max. Weight</b>	50kg

## 3674F/G/H Technical Specification

Frequency Characteristic		
Frequency Range	10M Hz ~ 32/44/50GHz	
Frequency Resolution	0.1Hz	
Frequency Accuracy	$\pm 1 \times 10^{-7} (23^{\circ}\text{C} \pm 3^{\circ}\text{C})$	
Harmonics		Typical
Port 1,3 Harmonics	-48dBc(0.01 ~ 4GHz)	-68dBc(0.01 ~ 4GHz)
	-57dBc(4 ~ 14GHz)	-70dBc(4 ~ 14GHz)
	-57dBc(14 ~ 50GHz)	-70dBc(14 ~ 50GHz)
Port 2,4 Harmonics	-13dBc(0.01 ~ 4GHz)	-18dBc(0.01 ~ 4GHz)
	-18dBc(4 ~ 14GHz)	-31dBc(4 ~ 14GHz)
	-57dBc(14 ~ 50GHz)	-70dBc(14 ~ 50GHz)
Port Power Characteristics		Typical
Power Sweep Range	37dB(10 ~ 50MHz)	42dB(10 ~ 50MHz)
	38dB(0.05 ~ 2GHz)	44dB(0.05 ~ 2GHz)
	35dB(2 ~ 4GHz)	41dB(2 ~ 4GHz)
	38dB(4 ~ 26.5GHz)	41dB(4 ~ 26.5GHz)
	37dB(26.5 ~ 30GHz)	42dB(26.5 ~ 30GHz)
	36dB(30 ~ 32GHz)	40dB(30 ~ 32GHz)
	37dB(32 ~ 35GHz)	43dB(32 ~ 35GHz)
	34dB(35 ~ 44GHz)	39dB(35 ~ 44GHz)
	30dB(44 ~ 47GHz)	38dB(44 ~ 47GHz)
20dB(47 ~ 50GHz)	36dB(47 ~ 50GHz)	
Maximum Leveled Power (Standard Configuration, Option 400)	+12dBm(10MHz ~ 50MHz)	+14dBm(10MHz ~ 50MHz)
	+12dBm(0.05GHz ~ 4GHz)	+13dBm(0.05GHz ~ 4GHz)
	+12dBm(4GHz ~ 14GHz)	+14dBm(4GHz ~ 14GHz)
	+13dBm(14GHz ~ 20GHz)	+14dBm(14GHz ~ 20GHz)

	+13dBm(20GHz ~ 26.5GHz) +12dBm(26.5GHz ~ 40GHz) +9dBm(40GHz ~ 47GHz) +5dBm(47GHz ~ 50GHz)	+14dBm(20GHz ~ 26.5GHz) +15dBm(26.5GHz ~ 40GHz) +13dBm(40GHz ~ 47GHz) +10dBm(47GHz ~ 50GHz)
<b>Maximum Leveled Power (400+401+402+404+003 Option)</b>	+9dBm(10MHz ~ 50MHz) +4dBm(0.05GHz ~ 4GHz) +4dBm(4GHz ~ 14GHz) +8dBm(14GHz ~ 20GHz) +6dBm(20GHz ~ 26.5GHz) +4dBm(26.5GHz ~ 40GHz) -1dBm(40GHz ~ 47GHz) -5dBm(47GHz ~ 50GHz)	+10dBm(10MHz ~ 50MHz) +7dBm(0.05GHz ~ 4GHz) +7dBm(4GHz ~ 14GHz) +9dBm(14GHz ~ 20GHz) +9dBm(20GHz ~ 26.5GHz) +7dBm(26.5GHz ~ 40GHz) +1dBm(40GHz ~ 47GHz) 0dBm(47GHz ~ 50GHz)
<b>Pulse Characteristic</b>		<b>Typical</b>
<b>Pulse Period</b>	33n s ~ 60s	20ns ~ 70s
<b>Pulse ON/OFF Ratio</b>	64dB(0.01 ~ 4GHz) 80dB(4 ~ 50GHz)	
<b>Network Parameter Characteristic</b>		<b>Typical</b>
<b>System Dynamic Range (Standard Configuration, Option 400)</b>	89dB(10MHz ~ 50MHz) 106dB(50MHz ~ 500MHz) 130dB(0.5GHz ~ 4GHz) 130dB(4GHz ~ 14GHz) 128dB(14GHz ~ 20GHz) 130dB(20GHz ~ 26.5GHz) 125dB(26.5GHz ~ 40GHz) 122dB(40GHz ~ 47GHz) 102dB(47GHz ~ 50GHz)	104dB(10MHz ~ 50MHz) 122dB(50MHz ~ 500MHz) 137dB(0.5GHz ~ 4GHz) 139dB(4GHz ~ 14GHz) 138dB(14GHz ~ 20GHz) 138dB(20GHz ~ 26.5GHz) 133dB(26.5GHz ~ 40GHz) 130dB(40GHz ~ 47GHz) 111dB(47GHz ~ 50GHz)

<b>System Dynamic Range</b> <b>(400+401+402+404+003 Option)</b>	83dB(10MHz ~ 50MHz) 100dB(50MHz ~ 500MHz) 114dB(0.5GHz ~ 4GHz) 112dB(4GHz ~ 14GHz) 116dB(14GHz ~ 20GHz) 114dB(20GHz ~ 26.5GHz) 112dB(26.5GHz ~ 40GHz) 106dB(40GHz ~ 47GHz) 100dB(47GHz ~ 50GHz)	97dB(10MHz ~ 50MHz) 108dB(50MHz ~ 500MHz) 125dB(0.5GHz ~ 4GHz) 132dB(4GHz ~ 14GHz) 128dB(14GHz ~ 20GHz) 127dB(20GHz ~ 26.5GHz) 125dB(26.5GHz ~ 40GHz) 119dB(40GHz ~ 47GHz) 104dB(47GHz ~ 50GHz)
<b>Directivity</b>	41dB(0.01 ~ 2GHz) 38dB(2 ~ 20GHz) 36dB(20 ~ 50GHz)	59dB(0.01 ~ 2GHz) 54dB(2 ~ 20GHz) 47dB(20 ~ 50GHz)
<b>Source Match</b>	31dB(0.01 ~ 2GHz) 30dB(2 ~ 20GHz) 23dB(20 ~ 50GHz)	45dB(0.01 ~ 2GHz) 36dB(2 ~ 20GHz) 31dB(20 ~ 50GHz)
<b>Load Match</b>	42dB(0.01 ~ 2GHz) 37dB(2 ~ 20GHz) 35dB(20 ~ 50GHz)	58dB(0.01 ~ 2GHz) 55dB(2 ~ 20GHz) 51dB(20 ~ 50GHz)
<b>Reflection Tracking</b>	±0.0150dB(0.01 ~ 2GHz) ±0.0290dB(2 ~ 20GHz) ±0.0300dB(20 ~ 40GHz) ±0.0400dB(40 ~ 50GHz)	±0.0046dB(0.01 ~ 2GHz) ±0.0022dB(2 ~ 20GHz) ±0.0020dB(20 ~ 40GHz) ±0.0065dB(40 ~ 50GHz)
<b>Transmission Tracking</b>	±0.051dB(10 ~ 50MHz) ±0.030dB(0.05 ~ 2GHz) ±0.095dB(2 ~ 10GHz) ±0.120dB(10 ~ 20GHz) ±0.200dB(20 ~ 40GHz)	±0.002dB(10 ~ 50MHz) ±0.004dB(0.05 ~ 2GHz) ±0.002dB(2 ~ 10GHz) ±0.002dB(10 ~ 20GHz) ±0.005dB(20 ~ 40GHz)

	±0.200dB(40 ~ 50GHz)	±0.002dB(40 ~ 50GHz)
<b>Others</b>		<b>Typical</b>
<b>Trace Noise Magnitude</b> <b>dB rms (1 kHz IF bandwidth)</b>	0.2000(10 ~ 50MHz)	0.0039(10 ~ 50MHz)
	0.0200(50 ~ 500MHz)	0.0006(50 ~ 500MHz)
	0.0030(0.5 ~ 1GHz)	0.0005(0.5 ~ 1GHz)
	0.0020(1 ~ 26.5GHz)	0.0006(1 ~ 26.5GHz)
	0.0030(26.5 ~ 44GHz)	0.0007(26.5 ~ 44GHz)
	0.0040(44 ~ 50GHz)	0.0008(44 ~ 50GHz)
<b>Trace Noise Phase</b> <b>Deg rms (1 kHz IF bandwidth)</b>	1.000(10 ~ 50MHz)	0.024(10 ~ 50MHz)
	0.500(50 ~ 500MHz)	0.004(50 ~ 500MHz)
	0.020(0.5 ~ 1GHz)	0.003(0.5 ~ 1GHz)
	0.020(1 ~ 26.5GHz)	0.004(1 ~ 26.5GHz)
	0.030(26.5 ~ 44GHz)	0.005(26.5 ~ 44GHz)
	0.030(26.5 ~ 50GHz)	0.005(26.5 ~ 50GHz)
<b>IF Bandwidth</b>	1Hz ~ 30M Hz	
<b>Display resolution Magnitude</b>	0.001dB /div	
<b>Display Resolution Phase</b>	0.001°/div	
<b>General Characteristic</b>		
<b>Port Connectors</b>	2.4mm (head), system impedance 50 ohms	
<b>Number of Measured Ports</b>	3674F / G / H standard standard: 2-port; 3674F / G / H-400 option: 4-port	
<b>Peripheral Interface</b>	GPIB interface, USB interface, DP interface, LAN interface	
<b>Display</b>	A 15.6-inch high-resolution touch display	
<b>Dimensions</b>	Overall dimensions (width and depth, including handles, feet and pads): 2-port: 475mm *279mm *560mm 4-port: 475mm *279mm *660mm	
<b>Max. Power Consumption</b>	500W	
<b>Power Supply</b>	50Hz single-phase 220V or 50Hz / 60Hz single-phase 110V AC	
<b>Max. Weight</b>	50kg	

## 3674K/L Technical Specification

Frequency Characteristic		
Frequency Range	10M Hz ~ 53/67GHz	
Frequency Resolution	0.1Hz	
Frequency Accuracy	$\pm 1 \times 10^{-7} (23^{\circ}\text{C} \pm 3^{\circ}\text{C})$	
Harmonics		Typical
Port 1,3 Harmonics	-48dBc(0.01 ~ 4GHz)	-57dBc(0.01 ~ 4GHz)
	-57dBc(4 ~ 14GHz)	-70dBc(4 ~ 14GHz)
	-57dBc(14 ~ 67GHz)	-71dBc(14 ~ 67GHz)
Port 2,4 Harmonics	-13dBc(0.01 ~ 4GHz)	-25dBc(0.01 ~ 4GHz)
	-18dBc(4 ~ 14GHz)	-32dBc(4 ~ 14GHz)
	-57dBc(14 ~ 67GHz)	-72dBc(14 ~ 67GHz)
Port Power Characteristics		Typical
Power Sweep Range	35dB(10 ~ 50MHz)	41dB(10 ~ 50MHz)
	38dB(0.05 ~ 2GHz)	44dB(0.05 ~ 2GHz)
	35dB(2 ~ 4GHz)	40dB(2 ~ 4GHz)
	38dB(4 ~ 10GHz)	42dB(4 ~ 10GHz)
	36dB(10 ~ 14GHz)	43dB(10 ~ 14GHz)
	37dB(14 ~ 16GHz)	42dB(14 ~ 16GHz)
	35dB(16 ~ 19GHz)	40dB(16 ~ 19GHz)
	34dB(19 ~ 26.5GHz)	37dB(19 ~ 26.5GHz)
	33dB(26.5 ~ 30GHz)	37dB(26.5 ~ 30GHz)
	32dB(30 ~ 32GHz)	36dB(30 ~ 32GHz)
32dB(32 ~ 35GHz)	39dB(32 ~ 35GHz)	
30dB(35 ~ 40GHz)	36dB(35 ~ 40GHz)	
35dB(40 ~ 67GHz)	40dB(40 ~ 67GHz)	
Maximum Leveled Power	+10dBm(10MHz ~ 50MHz)	+16dBm(10MHz ~ 50MHz)

<b>(Standard Configuration, Option 400)</b>	+10dBm(0.05GHz ~ 14GHz) +12dBm(14GHz ~ 20GHz) +11dBm(20GHz ~ 26.5GHz) +10dBm(26.5GHz ~ 30GHz) +7dBm(30GHz ~ 32GHz) +9dBm(32GHz ~ 35GHz) +5dBm(35GHz ~ 40GHz) +10dBm(40GHz ~ 67GHz)	+14dBm(0.05GHz ~ 14GHz) +16dBm(14GHz ~ 20GHz) +14dBm(20GHz ~ 26.5GHz) +13dBm(26.5GHz ~ 30GHz) +10dBm(30GHz ~ 32GHz) +12dBm(32GHz ~ 35GHz) +11dBm(35GHz ~ 40GHz) +16dBm(40GHz ~ 67GHz)
<b>Maximum Leveled Power (400+401+402+404+003 Option)</b>	+6dBm(10MHz ~ 50MHz) +4dBm(0.05GHz ~ 14GHz) +4dBm(14GHz ~ 20GHz) +4dBm(20GHz ~ 26.5GHz) -2dBm(26.5GHz ~ 30GHz) -2dBm(30GHz ~ 32GHz) -2dBm(32GHz ~ 35GHz) -2dBm(35GHz ~ 40GHz) -2dBm(40GHz ~ 67GHz)	+10dBm(10MHz ~ 50MHz) +9dBm(0.05GHz ~ 14GHz) +11dBm(14GHz ~ 20GHz) +7dBm(20GHz ~ 26.5GHz) +6dBm(26.5GHz ~ 30GHz) +4dBm(30GHz ~ 32GHz) +5dBm(32GHz ~ 35GHz) +3dBm(35GHz ~ 40GHz) +4dBm(40GHz ~ 67GHz)
<b>Pulse Characteristic</b>		<b>Typical</b>
<b>Pulse Period</b>	33ns ~ 60s	20ns ~ 70s
<b>Pulse ON/OFF Ratio</b>	64dB(0.01 ~ 4GHz) 80dB(4 ~ 67GHz)	
<b>Network Parameter Characteristic</b>		<b>Typical</b>
<b>System Dynamic Range (Standard, 400 option)</b>	87dB(10 ~ 50MHz) 110dB(50 ~ 500MHz) 127dB(0.5 ~ 4GHz) 130dB(4 ~ 14GHz) 129dB(14 ~ 26.5GHz)	102dB(10 ~ 50MHz) 124dB(50 ~ 500MHz) 137dB(0.5 ~ 4GHz) 142dB(4 ~ 14GHz) 138dB(14 ~ 26.5GHz)

	<p>120dB(26.5 ~ 40GHz)</p> <p>116dB(40 ~ 50GHz)</p> <p>107dB(50 ~ 60GHz)</p> <p>106dB(60 ~ 67GHz)</p>	<p>134dB(26.5 ~ 40GHz)</p> <p>128dB(40 ~ 50GHz)</p> <p>118dB(50 ~ 60GHz)</p> <p>116dB(60 ~ 67GHz)</p>
<p><b>System Dynamic Range</b> <b>(400+401+402+404+003</b> <b>Option)</b></p>	<p>84dB(10MHz ~ 50MHz)</p> <p>101dB(50MHz ~ 500MHz)</p> <p>114dB(0.5GHz ~ 4GHz)</p> <p>113dB(4GHz ~ 14GHz)</p> <p>113dB(14GHz ~ 26.5GHz)</p> <p>105dB(26.5GHz ~ 40GHz)</p> <p>106dB(40GHz ~ 50GHz)</p> <p>101dB(50GHz ~ 60GHz)</p> <p>100dB(60GHz ~ 67GHz)</p>	<p>100dB(10MHz ~ 50MHz)</p> <p>120dB(50MHz ~ 500MHz)</p> <p>129dB(0.5GHz ~ 4GHz)</p> <p>130dB(4GHz ~ 14GHz)</p> <p>128dB(14GHz ~ 26.5GHz)</p> <p>118dB(26.5GHz ~ 40GHz)</p> <p>115dB(40GHz ~ 50GHz)</p> <p>112dB(50GHz ~ 60GHz)</p> <p>106dB(60GHz ~ 67GHz)</p>
<p><b>Directivity</b></p>	<p>35dB(0.01 ~ 2GHz)</p> <p>41dB(2 ~ 10GHz)</p> <p>38dB(10 ~ 20GHz)</p> <p>37dB(20 ~ 35GHz)</p> <p>37dB(35 ~ 50GHz)</p> <p>34dB(50 ~ 67GHz)</p>	<p>65dB(0.01 ~ 2GHz)</p> <p>65dB(2 ~ 10GHz)</p> <p>59dB(10 ~ 20GHz)</p> <p>54dB(20 ~ 35GHz)</p> <p>48dB(35 ~ 50GHz)</p> <p>40dB(50 ~ 67GHz)</p>
<p><b>Source Match</b></p>	<p>34dB(0.01 ~ 2GHz)</p> <p>36dB(2 ~ 10GHz)</p> <p>40dB(10 ~ 20GHz)</p> <p>34dB(20 ~ 35GHz)</p> <p>28dB(35 ~ 50GHz)</p> <p>28dB(50 ~ 67GHz)</p>	<p>43dB(0.01 ~ 2GHz)</p> <p>40dB(2 ~ 10GHz)</p> <p>42dB(10 ~ 20GHz)</p> <p>38dB(20 ~ 35GHz)</p> <p>31dB(35 ~ 50GHz)</p> <p>31dB(50 ~ 67GHz)</p>
<p><b>Load Match</b></p>	<p>34dB(0.01 ~ 2GHz)</p> <p>40dB(2 ~ 10GHz)</p>	<p>59dB(0.01 ~ 2GHz)</p> <p>66dB(2 ~ 10GHz)</p>

	36dB(10 ~ 20GHz) 35dB(20 ~ 35GHz) 36dB(35 ~ 50GHz) 33dB(50 ~ 67GHz)	66dB(10 ~ 20GHz) 57dB(20 ~ 35GHz) 59dB(35 ~ 50GHz) 55dB(50 ~ 67GHz)
<b>Reflection Tracking</b>	±0.0200dB(0.01 ~ 2GHz) ±0.0110dB(2 ~ 10GHz) ±0.0330dB(10 ~ 35GHz) ±0.0200dB(35 ~ 50GHz) ±0.0310dB(50 ~ 67GHz)	±0.0050dB(0.01 ~ 2GHz) ±0.0016dB(2 ~ 10GHz) ±0.0037dB(10 ~ 35GHz) ±0.0045dB(35 ~ 50GHz) ±0.0180dB(50 ~ 67GHz)
<b>Transmission Tracking</b>	±0.100dB(0.01 ~ 2GHz) ±0.065dB(2 ~ 10GHz) ±0.100dB(10 ~ 20GHz) ±0.110dB(20 ~ 35GHz) ±0.094dB(35 ~ 50GHz) ±0.140dB(50 ~ 60GHz) ±0.150dB(60 ~ 67GHz)	±0.002dB(0.01 ~ 2GHz) ±0.002dB(2 ~ 10GHz) ±0.002dB(10 ~ 20GHz) ±0.003dB(20 ~ 35GHz) ±0.004dB(35 ~ 50GHz) ±0.006dB(50 ~ 60GHz) ±0.009dB(60 ~ 67GHz)
<b>Others</b>		<b>Typical</b>
<b>Trace Noise Magnitude</b> dB rms (1 kHz IF bandwidth)	0.0500(10 ~ 50MHz) 0.0040(50 ~ 100MHz) 0.0020(100 ~ 500MHz) 0.0030(0.5 ~ 1GHz) 0.0020(1 ~ 26.5GHz) 0.0030(26.5 ~ 50GHz) 0.0300(50 ~ 67GHz)	0.0042(10 ~ 50MHz) 0.0030(50 ~ 100MHz) 0.0006(100 ~ 500MHz) 0.0004(0.5 ~ 1GHz) 0.0003(1 ~ 26.5GHz) 0.0009(26.5 ~ 50GHz) 0.0077(50 ~ 67GHz)
<b>Trace Noise Phase</b> Deg rms (1 kHz IF bandwidth)	0.400(10 ~ 50MHz) 0.020(0.05 ~ 26.5GHz) 0.030(26.5 ~ 50GHz)	0.029(10 ~ 50MHz) 0.008(0.05 ~ 26.5GHz) 0.008(26.5 ~ 50GHz)

	0.200(50 ~ 67GHz)	0.051(50 ~ 67GHz)
<b>IF Bandwidth</b>	1Hz ~ 30M Hz	
<b>Display resolution Magnitude</b>	0.001dB /div	
<b>Display Resolution Phase</b>	0.001°/div	
<b>General Characteristic</b>		
<b>Port Connectors</b>	1.85mm (head), system impedance 50 ohms	
<b>Number of Measured Ports</b>	3674K / L standard: 2 ports; 3674K / L-400 option: 4 ports	
<b>Peripheral Interface</b>	GPIB interface, USB interface, DP interface, LAN interface	
<b>Display</b>	A 15.6-inch high-resolution touch display	
<b>Dimensions</b>	Overall dimensions (width and depth, including handles, feet and pads): 2-port: 475mm* 279mm* 560mm 4-port: 475mm *279mm* 660mm	
<b>Max. Power Consumption</b>	500W	
<b>Power Supply</b>	50Hz single-phase 220V or 50Hz / 60Hz single-phase 110V AC	
<b>Max. Weight</b>	50kg	

## 3674N/P Technical Specification

Frequency Characteristic		
Frequency Range	3674N: 10MHz ~ 90GHz 3674P: 10MHz ~ 110GHz 3674PA: 10MHz ~ 110GHz 3674QA: 10MHz ~ 120GHz	
Frequency Resolution	1Hz	
Frequency Accuracy	$\pm 1 \times 10^{-7} (23^{\circ}\text{C} \pm 3^{\circ}\text{C})$	
	3674N/P	3674PA/QA
Harmonics	-13dBc(0.01GHz ~ 3.2GHz) -25dBc(3.2GHz ~ 14GHz) -51dBc(14GHz ~ 45GHz) -31dBc(45GHz ~ 55GHz)	-13dBc(0.01GHz ~ 3.2GHz) -25dBc(3.2GHz ~ 14GHz) -31dBc(14GHz ~ 60GHz)
Port Power Characteristics	3674N/P	3674PA/QA
Maximum Leveled Power	+10dBm(10MHz ~ 50MHz) +10dBm(0.05GHz ~ 2GHz) +10dBm(2GHz ~ 30GHz) +5dBm(30GHz ~ 40GHz) +1dBm(40GHz ~ 90GHz) +0dBm(90GHz ~ 110GHz)	+5dBm(10MHz ~ 50MHz) +10dBm(0.05GHz ~ 2GHz) +8dBm(2GHz ~ 3.2GHz) +10dBm(3.2GHz ~ 10GHz) +5dBm(10GHz ~ 24GHz) +1dBm(24GHz ~ 40GHz) +3dBm(40GHz ~ 60GHz) +0dBm(60GHz ~ 110GHz) -5dBm(110GHz ~ 120GHz)
	3674N/P	3674PA/QA
Pulse Characteristic		
Pulse Period	33n s ~ 60s	/
Pulse ON/OFF Ratio	64dB(0.01 ~ 4GHz)	/

	70dB(4 ~ 90GHz)	
<b>Network Parameter</b>	<b>3674N/P</b>	<b>3674PA/QA</b>
<b>Characteristic</b>		
<b>System Dynamic Range</b>	70dB(10MHz ~ 500MHz) 110dB(0.5GHz ~ 1GHz) 110dB(1GHz ~ 26.5GHz) 107dB(26.5GHz ~ 35GHz) 95dB(35GHz ~ 50GHz) 90dB(50GHz ~ 72GHz) 100dB(72GHz ~ 90GHz) 95dB(90GHz ~ 110GHz)	70dB(10MHz ~ 500MHz) 105dB(0.5GHz ~ 1GHz) 110dB(1GHz ~ 26.5GHz) 107dB(26.5GHz ~ 50GHz) 90dB(50GHz ~ 72GHz) 100dB(72GHz ~ 90GHz) 90dB(90GHz ~ 110GHz) 80dB(110GHz ~ 120GHz)
<b>Directivity</b>	35dB(0.01GHz ~ 3.2GHz) 30dB(3.2GHz ~ 10GHz) 24dB(10GHz ~ 50GHz) 23dB(50GHz ~ 67GHz) 20dB(67GHz ~ 90GHz) 20dB(90GHz ~ 110GHz)	25dB(0.01GHz ~ 3.2GHz) 25dB(3.2GHz ~ 10GHz) 20dB(10GHz ~ 67GHz) 22dB(67GHz ~ 90GHz) 20dB(90GHz ~ 110GHz) 20dB(110GHz ~ 120GHz)
<b>Load Match</b>	35dB(0.01GHz ~ 3.2GHz) 36dB(3.2GHz ~ 10GHz) 33dB(10GHz ~ 26.5GHz) 30dB(26.5GHz ~ 50GHz) 25dB(50GHz ~ 67GHz) 20dB(67GHz ~ 90GHz) 20dB(90GHz ~ 110GHz)	29dB(0.01GHz ~ 3.2GHz) 30dB(3.2GHz ~ 10GHz) 28dB(10GHz ~ 26.5GHz) 30dB(26.5GHz ~ 50GHz) 26dB(50GHz ~ 90GHz) 25dB(90GHz ~ 110GHz) 25dB(110GHz ~ 120GHz)
<b>Reflection Tracking</b>	±0.050dB(0.01GHz ~ 3.2GHz) ±0.030dB(3.2GHz ~ 10GHz) ±0.033dB(10GHz ~ 26.5GHz)	±0.080dB(0.01GHz ~ 3.2GHz) ±0.055dB(3.2GHz ~ 10GHz) ±0.090dB(10GHz ~ 26.5GHz)

	<p>±0.080dB(26.5GHz ~ 50GHz)</p> <p>±0.091dB(50GHz ~ 67GHz)</p> <p>±0.095dB(67GHz ~ 90GHz)</p> <p>±0.099dB(90GHz ~ 110GHz)</p>	<p>±0.075dB(26.5GHz ~ 50GHz)</p> <p>±0.150dB(50GHz ~ 67GHz)</p> <p>±0.250dB(67GHz ~ 90GHz)</p> <p>±0.300dB(90GHz ~ 110GHz)</p> <p>±0.300dB(110GHz ~ 120GHz)</p>
<b>Transmission Tracking</b>	<p>±0.149dB(0.01GHz ~ 3.2GHz)</p> <p>±0.090dB(3.2GHz ~ 10GHz)</p> <p>±0.110dB(10GHz ~ 26.5GHz)</p> <p>±0.130dB(26.5GHz ~ 50GHz)</p> <p>±0.150dB(50GHz ~ 67GHz)</p> <p>±0.200dB(67GHz ~ 90GHz)</p> <p>±0.300dB(90GHz ~ 110GHz)</p>	<p>±0.260dB(0.01GHz ~ 3.2GHz)</p> <p>±0.164dB(3.2GHz ~ 10GHz)</p> <p>±0.101dB(10GHz ~ 26.5GHz)</p> <p>±0.189dB(26.5GHz ~ 50GHz)</p> <p>±0.343dB(50GHz ~ 67GHz)</p> <p>±0.449dB(67GHz ~ 90GHz)</p> <p>±0.483dB(90GHz ~ 110GHz)</p> <p>±0.483dB(110GHz ~ 120GHz)</p>
<b>Others</b>	<b>3674N/P</b>	<b>3674PA/QA</b>
<b>Trace Noise Magnitude</b> dB rms (1 kHz IF bandwidth)	<p>0.050(10MHz ~ 100MHz)</p> <p>0.004(0.1GHz ~ 26.5GHz)</p> <p>0.007(26.5GHz ~ 50GHz)</p> <p>0.009(50GHz ~ 90GHz)</p> <p>0.009(90GHz ~ 110GHz)</p>	<p>0.200(10MHz ~ 100MHz)</p> <p>0.007(0.1GHz ~ 26.5GHz)</p> <p>0.004(26.5GHz ~ 50GHz)</p> <p>0.007(50GHz ~ 110GHz)</p> <p>0.009(110GHz ~ 120GHz)</p>
<b>IF Bandwidth</b>	1Hz ~ 30MHz	
<b>Display resolution Magnitude</b>	0.001dB /div	
<b>Display Resolution Phase</b>	0.01°/div	
<b>General Characteristic</b>		
<b>Port Connectors</b>	1.0mm (head), system impedance 50 ohms	
<b>Number of Measured Ports</b>	3674N/P Standard: 2 ports , 3674N/P-400: 4 ports	
<b>Peripheral Interface</b>	GPIB interface, USB interface, DP interface, LAN interface	
<b>Display</b>	A 15.6-inch high-resolution touch display	

<b>Dimensions</b>	Overall dimensions (width and depth, including handles, feet and pads): 2-port: 475mm ×279mm ×560mm 4-port: 475mm ×279mm× 660mm
<b>Max. Power Consumption</b>	3674N/P : 500W 3674PA/QA : 600W
<b>Power Supply</b>	50Hz single-phase 220V or 50Hz / 60Hz single-phase 110V AC
<b>Max. Weight</b>	3674N/P : 50kg 3674PA/QA : 84kg

Note: The typical value refers to the performance information of other products that are not within the range of the product "guarantee index", and about 80% of the instruments can achieve the performance index in the temperature range of 20 ° C ~ 30 ° C. Typical values do not include uncertainties in the measurement process.

## Ordering Information

Model	Description
3674B	Vector Network Analyzer (10 MHz ~ 9 GHz)
3674C	Vector Network Analyzer (10 MHz ~ 14 GHz)
3674D	Vector Network Analyzer (10 MHz ~ 20 GHz)
3674E	Vector Network Analyzer (10MHz ~26.5GHz)
3674F	Vector Network Analyzer (10 MHz ~ 32 GHz)
3674G	Vector Network Analyzer (10 MHz ~ 44 GHz)
3674H	Vector Network Analyzer (10 MHz ~ 50 GHz)
3674K	Vector Network Analyzer (10 MHz ~ 53 GHz)
3674L	Vector Network Analyzer (10 MHz ~ 67 GHz)
3674N	Vector Network Analyzer (10 MHz ~ 90 GHz)
3674P	Vector Network Analyzer (10 MHz ~ 110 GHz)

### Standard Configuration

No.	Model	Quantity	Description
1	Power Cord Assembly	1	Standard three-core power cord
2	USB Mouse	1	
3	Quick Operation Guide	2	
4	Certificate of Conformity	1	
5	Aluminum Alloy Box	1	

### 3674PA Vector Network Analyzer (10 MHz~110 GHz) System Configuration

No.	Name	Configuration	
		2-port model	4-port model
1	Vector Network Analyzer and options	3674E/F/G/H/K/L+S20	3674E/F/G/H/K/L+400+S20
2	Millimeter Wave Test Set	3674-009	3674-010
3	Coaxial Frequency Extender	3674-011 (Quantity 2)	3674-011 (Quantity 4)

### 3674 Series Vector Network Analyzer General Option

No.	Model	Name	Function
1.	3674-006	English Version Option	With English front and rear panel and English operating system.
2.	3674-007	Linux Operating system	Configure the Linux operating system to replace the Windows operating system.
3.	3674-009	2-port Millimeter Wave Test Set	It is used for expanding the frequency of the vector network analyzer to expand the two-port vector network analyzer.  Requires: Option 3674-S20.
4.	3674-010	4-port Millimeter Wave Test Set	It is used for the frequency expansion of vector network analyzer to realize the expansion function of four-port vector network analyzer.  Requires: Option 3674-S20.
5.	3674-011	110GHz Coaxial Frequency Extender	For vector network analyzer frequency expansion to achieve coaxial S parameter measurement from 10 MHz to 110 GHz. The second port requires two modules and the four modules.  2-Port Requires: Option 3674-009, 3674-S20.  4-Port Requires: Option 400 + 3674-010 + 3674-S20.
6.	3674-S05	S-parameter Signal Integrity Analysis Function	The signal integrity characteristics, such as frequency domain, time domain TDR and crosstalk, can automatically convert the graph curve into a test report.  For the full range.
7.	3674-S07	Automatic Fixture Removal Function(AFR)	For automatic testing and removal of single-end and balance device measuring fixture. For the full range.

8.	3674-S10	Time Domain measurement Function	For time domain measurements, you can determine and analyze the discontinuous positions in devices, fixtures, or cables. For the full range.
9.	3674-S11	Advanced Time Domain Analysis Function	For TDR time-domain impedance testing, eye-map analysis, etc. For the full range.
10.	3674-S16	True difference measurement function	For the real difference mode and common mode excitation balance parameters measurement. For 3674B / C / D / E / F / G / H / K / L. Requires: Option 400 + 404 + 3674-S28.
11.	3674-S18	Fast CW Sweep Function	Data was read immediately using the FIFO buffer method. For the full range.
12.	3674-S20	Frequency Offset Function	For the frequency offset measurements. For the full range.
13.	3674-S22	Mixer/Converter Scalar Measurement	For the mixer scalar parameter measurement. For 3674B / C / D / E / F / G / H / K / L. Requires: Option 400+S20.
14.	3674-S24	Embedded LO Frequency Converter Measurement	Used for embedded local vibration Converter measurement. For 3674B / C / D / E / F / G / H / K / L. Requires: Option 400+S20+S22/023
15.	3674-S26	Gain Compression Measurement	Gain compression measurement for active devices such as amplifiers. For 3674B / C / D / E / F / G / H / K / L.
16.	3674-S28	Phase-scan Measurement	For the phase-scan measurements. For 3674B / C / D / E / F / G / H / K / L. Requires: Option 400.

17.	3674-S29	Differential measurement	I/Q	This instrument is suitable for testing differential and I/Q mixers, amplifiers, etc. It can measure the frequency conversion loss or gain, LO feedthrough, oscillator isolation, differential harmonics, total harmonic distortion (THD), and image rejection of the measured device under differential or I/Q excitation. It supports arbitrary phase, power, and frequency customization for measurement. It is compatible with 3674B/C/D/E/F/G/H/K/L. The optional accessories include 400+S20+S28.
18.	3674-042	Millimeter Wave Test Set-Waveguide Frequency Extender Bundle Cable		For the vector network analyzer waveguide expansion system, the spread frequency controller interconnects with the waveguide spread spectrum module, including two ports and four ports.  Configure two sets of 2-port and 4 sets of 4-port.
19.	3674-043	3674E 4-port Frequency Extension System Cable		It is used for four-port vector network analyzer and waveguide spread frequency module.
20.	3674-044	3674F/G/H 4-port Frequency Extension System Cable		It is used for four-port vector network analyzer and waveguide spread frequency module.
21.	3674-045	3674K/L 4-port Frequency Extension System Cable		It is used for four-port vector network analyzer and waveguide spread frequency module.
22.	3674-061	Extension Table for Test		Desktop extension for the test, length and width =500mm 350mm.
23.	3674-062	Rack mount kit		Dedicated kit installed in the cabinet.
24.	3674-063	User Manual (paper version)		Provide a detailed user manual in the paper version.

25.	3674-GZ	Product modification service	This option is required when you add hardware options after returning to the factory for upgrade.
26.		31101 N-type 50 Ω Mechanical calibration kit	For complete machine calibration (DC~18GHz)
27.		31121A 3.5mm Mechanical calibration kit	For complete machine calibration (DC~6GHz)
28.		31121 3.5mm Mechanical calibration kit	For complete machine calibration (DC~26.5GHz)
29.		20202 3.5mm Mechanical calibration kit	For complete machine calibration (DC~9GHz)
30.		31123 2.4mm Mechanical calibration kit	For complete machine calibration (DC~40GHz)
31.		31123A 2.4mm Mechanical calibration kit	For complete machine calibration (DC~50GHz)
32.		20402 Electronic calibration kit	For overall calibration (300 kHz ~ 18 GHz N 2 port)
33.		20403 Electronic calibration kit	For complete machine calibration (10MHz~26.5GHz 3.5mm 2-port)
34.		20404 Electronic calibration kit	For overall calibration (10 MHz ~ 50 GHz 2.4 mm 2-port)
35.		20405 Electronic calibration kit	For overall calibration (10 MHz to 20 GHz 3.5 mm four-port)
36.		20409 Electronic calibration kit	For overall calibration (10 MHz ~ 67 GHz 1.85 mm 2-port)
37.		FB0HA0HB025.0 3.5mm Gore test cable	For complete machine measurement (3.5mm -Male) Suitable for 3674B / C / D / E

38.		FB0HA0HC025.0 3.5mm Gore test cable	For complete machine measurement (test end 3.5mm -Female) Suitable for 3674B / C / D / E
39.		FB0HA0AH025.0 3.5mm-N-type Gore test cable	For machine measurement (N type at test end) Suitable for 3674B / C / D / E
40.		FB0HA0AL025.0 3.5mm-N-type Gore test cable	For the complete machine measurement (N-type -Female at the test end) Suitable for 3674B / C / D / E
41.		FE0BN0BM025.0 2.4mm Gore test cable	For complete machine measurement (2.4mm -Male) Suitable for 3674F / G / H
42.		FE0BN0BL025.0 2.4mm Gore test cable	For complete machine measurement (test end 2.4mm -Female) Suitable for 3674F / G / H
43.		FE0BN0AH025.0 2.4mm-N-type Gore test cable	For machine measurement (N type at test end) Suitable for 3674F / G / H
44.		FE0BN0AL025.0 The 2.4mm-N type Gore test cable	For the complete machine measurement (N-type -Female at the test end) Suitable for 3674F / G / H
45.		FE0BN0HB025.0 2.4mm-3.5mm Gore test cable	For complete machine measurement (3.5mm -Male) Suitable for 3674F / G / H
46.		FE0BN0HC025.0 2.4mm-3.5mm Gore test cable	For complete machine measurement (test end 3.5mm -Female) Suitable for 3674F / G / H

47.		FE0BN0HR025.0 2.4mm-2.92mm Gore test cable	For complete machine measurement (test end 2.92mm -Male)  Suitable for 3674F / G / H
48.		FE0BN0HQ025.0 2.4mm-2.92mm Gore test cable	For complete machine measurement (2.92mm shade at test end), Suitable for 3674F / G / H
49.		FF0CN0CM025.0 1.85mm Gore test cable	For machine measurement (1.85mm -Male)  Suitable for 3674K / L
50.		FF0CN0CL025.0 1.85mm Gore test cable	For complete machine measurement (test end 1.85mm -Female), Suitable for 3674K / L
51.		87308 3.5mm test cable	For complete machine measurement (3.5mm -Male)  Suitable for 3674B / C / D / E
52.		87308A 3.5mm test cable	For complete machine measurement (test end 3.5mm -Female), Suitable for 3674B / C / D / E
53.		87308HA 2.4mm test cable	For complete machine measurement (test end 2.4mm -Female), Suitable for 3674F / G / H
54.		87308HB 2.4mm test cable	For complete machine measurement (2.4mm -Male)  Suitable for 3674F / G / H
55.		87302NN 1.85mm test cable	For complete machine measurement (test end 1.85mm -Female) Suitable for 3674K / L
56.		87302NM 1.85mm test cable	For machine measurement (1.85mm -Male)  Suitable for 3674K / L
57.		87230 USB Power Sensor	For power calibration (9 kHz ~ 6 GHz)
58.		87231 USB Power Sensor	For power calibration (10 MHz ~ 18 GHz)
59.		87232 USB Power Sensor	For power calibration (50MHz~26.5GHz)
60.		87233 USB Power Sensor	For power calibration (50 MHz ~ 40 GHz)

61.		87601 Microwave Assistant (Type-N)	Coaxial adaptor package (N-type interface converted to 3.5mm, 2.4mm interface, etc.)
62.		87601A Microwave Assistant (3.5mm)	Coaxial adaptor package (3.5mm interface converted to N-type, 2.4mm interface, etc.)
63.		87601B Microwave Assistant (2.92mm)	Coaxial adapter package (2.92mm interface converted to 2.4mm interface, etc.)
64.		87601C Microwave Assistant (2.4mm)	Coaxial adaptor package (2.4mm interface to N, 3.5mm, 2.92mm, 1.85mm, etc.)

### 3674B Vector Network Analyzer Option

No.	Model	Name	Function
1.	3674B-003	Noise Figure Measurement	For accurate measurement of S parameters, noise coefficient, and noise parameters.  2-Port Requires: Option 3674B-201 + 3674B-204  4-Port Requires: Option 3674B-401 + 3674B-404.  (Note: Two-port electronic calibrators and ordinary noise sources need to be purchased separately.)
2.	3674B-008	Pulse Measurement	For the S parameter measurement in the pulse state, ports 1 and 3 outputs the pulse modulation signal.
3.	3674B-023	Mixer/Converter Vector Measurement	For the mixer-based vector parameter measurement.  Requires: Option 3674B-400 + 3674B-404 + 3674-S20.
4.	3674B-201	2-port Programmable Step Attenuator	Configure 2-70dB step attenuators for source path and 2-35dB step attenuators for receiver path.  Requires: Option 3674B-204.

5.	3674B-203	2-port 500Hz Low-frequency Expansion	The lower frequency range can be extended to 500Hz.  Requires: Option 3674B-204, 3674B-205 cannot be configured at the same time.
6.	3674B-204	Configurable Test Set	Expand the test device of the two-port model, add the panel jumper, and can use A, B, R1, R2 receiver independently.
7.	3674B-205	2-port T-type Bias-tees	Two T-type biasing devices are configured internally for the port output DC offset voltage.  Requires: Option 3674B-201+ 3674B-204, 3674B-203 cannot be configured at the same time.
8.	3674B-400	4-port measurement	Dual-source excitation four-port vector network analyzer configuration with a frequency range of 10 MHz to 9 GHz.
9.	3674B-401	4-port programmable Step Attenuator	Install 4-70dB step attenuators for source path and 4-35dB step attenuators for receiver path.  Requires: Option 3674B- 400 + 3674B-404.
10.	3674B-402	Active Intermodulation Distortion Measurement	For active intermodulation distortion signal measurement.  Requires: Option 3674B- 400 +3671B- 404 + 3674-S20.
11.	3674B-403	4-port 500Hz low-frequency expansion	The lower frequency range can be extended to 500Hz.  Requires: Option 3674B-400 + 3674B-404, 3674B-405 cannot be configured at the same time.

12.	3674B-404	Configurable Test Set	Expand the test device of the four-port model, add the panel jumper, and can independently use A, B, C, D, R1, R2, R3, R4 receivers.  Requires: Option 3674B-400.
13.	3674B-405	4-port T type Bias-tees	Four T-type biasing devices are configured internally for the port output DC offset voltage. Requires: Option 3674B-400 + 3674B-401 + 3672B-404.  3674B-403 cannot be configured at the same time.
14.	3674B-S30	Spectrum Analysis Function	Used to provide a multichannel spectrum testing function.
15.	3674B-JL	Calibration Services	Provide metrological calibration services and provide metrological reports
16.	3674B-EWT1	Extended warranty for 1 year	Beyond the warranty period, the warranty is extended for 1 year, and the two-year extended warranty is optional for 2 items, and so on

### The 3674C Vector Network Analyzer Option

No.	Model	Name	Function
1.	3674C-003	Noise Figure Measurement	For accurate measurement of S parameters, noise coefficient, and noise parameters.  2-Port Requires: Option 3674C-201 + 3674C-204.  4-Port Requires: Option 3674C- 401 + 3674C-404.  (Note: Two-port electronic calibrators and ordinary noise sources need to be purchased separately.)
2.	3674C-008	Pulse Measurement	For the S parameter measurement in the pulse state, ports 1 and 3 outputs the pulse modulation signal.

3.	3674C-023	Mixer/Converter Vector Measurement	For the mixer-based vector parameter measurement. Requires: Option 3674C-400 + 3674C-404 + 3674-S20.
4.	3674C-201	2-port Programmable Step Attenuator	Configure 2-70dB step attenuators for source path and 2-35dB step attenuators for receiver path. Requires: Option 3674C-204.
5.	3674C-203	2-port 500Hz Low-frequency Expansion	The lower frequency range can be extended to 500Hz. Requires: Option 3674C-204. 3674C-205 cannot be configured at the same time.
6.	3674C-204	Configurable Test Set	Expand the test device of the two-port model, add the panel jumper, and can use A, B, R1, R2 receiver independently.
7.	3674C-205	2-port T-type Bias-tees	Two T-type biasing devices are configured internally for the port output DC offset voltage. Requires: Option 3674C-201 +3674C- 204 3674C-203 cannot be configured at the same time.
8.	3674C-400	4-port measurement	Dual source excitation four-port vector network analyzer configuration with frequency range 10 MHz to 14 GHz.
9.	3674C-401	4-port programmable Step Attenuator	Install 4-70dB step attenuators for source path and 4-35dB step attenuators for receiver path. Requires: Option 3674C- 400 +3674C- 404.
10.	3674C-402	Active Intermodulation Distortion Measurement	For active intermodulation distortion signal measurement. Requires: Option 3674C- 400 +3674C- 404 + 3674-S20.

11.	3674C-403	4-port low-frequency expansion 500Hz	The lower frequency range can be extended to 500Hz.  Requires: Option 3674C- 400 +3674C- 404.  3674C-405 cannot be configured at the same time.
12.	3674C-404	Configurable Test Set	Expand the test device of the four-port model, add the panel jumper, and can independently use A, B, C, D, R1, R2, R3, R4 receivers.  Requires: Option 3674C- 400.
13.	3674C-405	4-port T type Bias-tees	Four T-type biasing devices are configured internally for the port output DC offset voltage.  Requires: Option 3674C- 400 +3674C- 401 + 3674C-404.  3674C-403 cannot be configured at the same time.
14.	3674C-S30	Spectrum Analysis Function	Used to provide a multichannel spectrum testing function.
15.	3674C-JL	Calibration Services	Provide metrological calibration services and provide metrological reports
16.	3674C-EWT1	Extended warranty for 1 year	Beyond the warranty period, the warranty is extended for 1 year, and the two-year extended warranty is optional for 2 items, and so on

## The 3674D Vector Network Analyzer Option

No.	Model	Name	Function
1.	3674D-003	Noise Figure Measurement	For accurate measurement of S parameters, noise coefficient, and noise parameters. Note: Two-port electronic calibrators and noise sources need to be purchased separately.  2-Port Requires: Option 3674D-201 + 3674D-204.  4-Port Requires: Option 3674D-401 + 3674D-404.
2.	3674D-008	Pulse Measurement	For the S parameter measurement in the pulse state, ports 1 and 3 outputs the pulse modulation signal.
3.	3674D-023	Mixer/Converter Vector Measurement	For the mixer-based vector parameter measurement.  Requires: Option 3674D-400 + 3674D-404 + 3674-S20.
4.	3674D-201	2-port Programmable Step Attenuator	Configure 2-70dB step attenuators for source path and 2-35dB step attenuators for receiver path.  Requires: Option 3674D- 204.
5.	3674D-203	2-port 500Hz Low-frequency Expansion	The lower frequency range can be extended to 500Hz.  Requires: Option 3674D- 204, 3674D-205 cannot be configured at the same time.
6.	3674D-204	Configurable Test Set	Expand the test device of the two-port model, add the panel jumper, and can use A, B, R1, R2 receiver independently.
7.	3674D-205	2-port T-type Bias-tees	Two T-type biasing devices are configured internally for the port output DC offset voltage.  Requires: Option 3674D-201 +3674D-204, 3674D-203 cannot be configured at the same time.

8.	3674D-400	4-port measurement	Dual-source excitation four-port vector network analyzer configuration with a frequency range of 10 MHz to 20 GHz.
9.	3674D-401	4-port programmable Step Attenuator	Install 4-70dB step attenuators for source path and 4-35dB step attenuators for receiver path.  Requires: Option 3674D- 400 +3674D- 404.
10.	3674D-402	Active Intermodulation Distortion Measurement	For active intermodulation distortion signal measurement.  Requires: Option 3674D- 400 + 3674D-404 + 3674-S20.
11.	3674D-403	4-port 500Hz low-frequency expansion	The lower frequency range can be extended to 500Hz.  Requires: Option 3674D-400 +3674D-404, 3674D-405 cannot be configured at the same time.
12.	3674D-404	Configurable Test Set	Expand the test device of the four-port model, add the panel jumper, and can independently use A, B, C, D, R1, R2, R3, R4 receivers.  Requires: Option 3674D-400.
13.	3674D-405	4-port T type Bias-tees	Four T-type biasing devices are configured internally for the port output DC offset voltage.  Requires: Option 3674D-400 + 3674D-401 + 3674D-404.  3674D-403 cannot be configured at the same time.
14.	3674D-S30	Spectrum Analysis Function	Used to provide a multichannel spectrum testing function.
15.	3674D-JL	Calibration Services	Provide metrological calibration services and provide metrological reports

16.	3674D-EWT1	Extended warranty for 1 year	Beyond the warranty period, the warranty is extended for 1 year, and the two-year extended warranty is optional for 2 items, and so on
-----	------------	------------------------------	--

### The 3674E Vector Network Analyzer Option

No.	Model	Name	Function
1.	3674E-003	Noise Figure Measurement	For accurate measurement of S parameters, noise coefficient, and noise parameters.  2-Port Requires: Option 3674E-201 + 3674E-204.  4-Port Requires: Option 3674E-401 +3674E-404.  (Note: Two-port electronic calibrators and ordinary noise sources need to be purchased separately.)
2.	3674E-008	Pulse Measurement	For the S parameter measurement in the pulse state, ports 1 and 3 output the pulse modulation signal.
3.	3674E-018	Multi-port Expansion Device	For the extended vector network analyzer is 16 port.  Requires: Option 3674E- 400 +3674E-404.
4.	3674E-023	Mixer/Converter Vector Measurement	For the mixer-based vector parameter measurement.  Requires: Option 3674E- 400 +3674E- 404 + 3674-S20.
5.	3674E-201	2-port Programmable Step Attenuator	Configure 2-70dB step attenuators for source path and 2-35dB step attenuators for receiver path.  Requires: Option 3674E-204.
6.	3674E-203	2-port 500Hz Low-frequency Expansion	The lower frequency range can be extended to 500Hz.  Requires: Option 3674E-204, 3674E-205 cannot be configured at the same time.
7.	3674E-204	Configurable Test Set	Expand the test device of the two-port model, add

			the panel jumper, and can use A, B, R1, R2 receiver independently.
8.	3674E-205	2-port T-type Bias-tees	Two T-type biasing devices are configured internally for the port output DC offset voltage.  Requires: Option 3674E-201 +3674E-204, 3674E-203 cannot be configured at the same time.
9.	3674E-400	4-port measurement	Dual-source excitation four-port vector network analyzer configuration with frequency range 10MHz~26.5GHz.
10.	3674E-401	4-port programmable Step Attenuator	Install 4-70dB step attenuators for source path and 4-35dB step attenuators for receiver path.  Requires: Option 3674E-400 +3674E- 404.
11.	3674E-402	Active Intermodulation Distortion Measurement	For active intermodulation distortion signal measurement.  Requires: Option 3674E-400 +3674E- 404 + 3674-S20.
12.	3674E-403	4-port 500Hz low-frequency expansion	The lower frequency range can be extended to 500Hz.  Requires: Option 3674E-400 +3674E-404, 3674E-405 cannot be configured at the same time.
13.	3674E-404	Configurable Test Set	Expand the test device of the four-port model, add the panel jumper, and can independently use A, B, C, D, R1, R2, R3, R4 receivers.  Requires: Option 3674E- 400.
14.	3674E-405	4-port T type Bias-tees	Four T-type biasing devices are configured internally for the port output DC offset voltage.  Requires: Option 3674E-400 +3674E-401 +

			3674E-404,3674E-403 cannot be configured at the same time.
15.	3674E-S30	Spectrum Analysis Function	Used to provide a multichannel spectrum testing function.
16.	3674E-JL	Calibration Services	Provide metrological calibration services and provide metrological reports
17.	3674E-EWT1	Extended warranty for 1 year	Beyond the warranty period, the warranty is extended for 1 year, and the two-year extended warranty is optional for 2 items, and so on

### The 3674F Vector Network Analyzer Option

No.	Model	Name	Function
1.	3674F-003	Noise Figure Measurement	For accurate measurement of S parameters, noise coefficient, and noise parameters.  2-Port Requires: Option 3674F-201 +3674F- 204.  4-Port Requires: Option 3674F-401 +3674F- 404.  (Note: Two-port electronic calibrators and ordinary noise sources need to be purchased separately.)
2.	3674F-008	Pulse Measurement	For the S parameter measurement in the pulse state, ports 1 and 3 output the pulse modulation signal.
3.	3674F-018	Multi-port Expansion Device	For the extended vector network analyzer is 16 port.  Requires: Option 3674F-400 +3674F-404.
4.	3674F-023	Mixer/Converter Vector	For the mixer-based vector parameter measurement.

		Measurement	Requires: Option 3674F-400 +3674F- 404 + 3674-S20.
5.	3674F-201	2-port Programmable Step Attenuator	Configure 2-60dB step attenuators for source path and 2-35dB step attenuators for receiver path.  Requires: Option 3674F-204.
6.	3674F-203	2-port 500Hz Low-frequency Expansion	The lower frequency range can be extended to 500Hz.  Requires: Option 3674F-204,  3674F-205 Can not be configured at the same time.
7.	3674F-204	Configurable Test Set	Expand the test device of the two-port model, add the panel jumper, and can use A, B, R1, R2 receiver independently.
8.	3674F-205	2-port T-type Bias-tees	Two T-type biasing devices are configured internally for the port output DC offset voltage.  Requires: Option 3674F-201 +3674F- 204,  3674F-203 cannot be configured at the same time.
9.	3674F-400	4-port measurement	Dual-source excitation four-port vector network analyzer configuration with a frequency range of 10 MHz to 32 GHz.
10.	3674F-401	4-port programmable Step Attenuator	Install 4-60dB step attenuators for source path and 4-35dB step attenuators for receiver path.  Requires: Option 3674F-400 +3674F- 404.
11.	3674F-402	Active Intermodulation Distortion Measurement	For active intermodulation distortion signal measurement.  Requires: Option 3674F-400 +3674F- 404 + 3674-S20.
12.	3674F-403	4-port 500Hz	The lower frequency range can be extended to

		low-frequency expansion	500Hz.  Requires: Option 3674F-400 +3674F-404,  3674F-405 cannot be configured at the same time.
13.	3674F-404	Configurable Test Set	Expand the test device of the four-port model, add the panel jumper, and can independently use A, B, C, D, R1, R2, R3, R4 receivers.  Requires: Option 3674F- 400.
14.	3674F-405	4-port T type Bias-tees	Four T-type biasing devices are configured internally for the port output DC offset voltage.  Requires: Option 3674F- 400 + 3674F-401 +3674F-404, 3674F-403 cannot be configured at the same time.
15.	3674F-S30	Spectrum Analysis Function	Used to provide a multichannel spectrum testing function.
16.	3674F-JL	Calibration Services	Provide metrological calibration services and provide metrological reports
17.	3674F-EWT1	Extended warranty for 1 year	Beyond the warranty period, the warranty is extended for 1 year, and the two-year extended warranty is optional for 2 items, and so on

### The 3674G Vector Network Analyzer Option

No.	Model	Name	Function
1.	3674G-003	Noise Figure Measurement	For accurate measurement of S parameters, noise coefficient, and noise parameters.  2-Port Requires: Option 3674G-201 + 3674G-204;  4-Port Requires: Option 3674G- 401 + 3674G-404.  (Note: Two-port electronic calibrators and ordinary

			noise sources need to be purchased separately.)
2.	3674G-008	Pulse Measurement	For the S parameter measurement in the pulse state, ports 1 and 3 output the pulse modulation signal.
3.	3674G-018	Multi-port Expansion Device	For the extended vector network analyzer is 16 port. Requires: Option 3674G-400 + 3674G-404.
4.	3674G-023	Mixer/Converter Vector Measurement	For the mixer-based vector parameter measurement. Requires: Option 3674G-400 +3674G-404 +3674-S20.
5.	3674G-201	2-port Programmable Step Attenuator	Configure 2-60dB step attenuators for source path and 2-35dB step attenuators for receiver path. Requires: Option 3674G-204.
6.	3674G-203	2-port 500Hz Low-frequency Expansion	The lower frequency range can be extended to 500Hz. Requires: Option 3674G-204, 3674G-205 cannot be configured at the same time.
7.	3674G-204	Configurable Test Set	Expand the test device of the two-port model, add the panel jumper, and can use A, B, R1, R2 receiver independently.
8.	3674G-205	2-port T-type Bias-tees	Two T-type biasing devices are configured internally for the port output DC offset voltage. Requires: Option 3674G-201+ 3674G-204, 3674G-203 cannot be configured at the same time.
9.	3674G-400	4-port measurement	Dual-source excitation four-port vector network analyzer configuration with a frequency range of 10 MHz to 44 GHz.
10.	3674G-401	4-port programmable Step Attenuator	Install 4-60dB step attenuators for source path and 4-35dB step attenuators for receiver path.

			Requires: Option 3674G-400 +3674G-404.
11.	3674G-402	Active Intermodulation Distortion Measurement	For active intermodulation distortion signal measurement.  Requires: Option 3674G-400 +3674G-404 +3674G-S20.
12.	3674G-403	4-port 500Hz low-frequency expansion	The lower frequency range can be extended to 500Hz.  Requires: Option 3674G-400 +3674G-404, 3674G-405 cannot be configured at the same time.
13.	3674G-404	Configurable Test Set	Expand the test device of the four-port model, add the panel jumper, and can independently use A, B, C, D, R1, R2, R3, R4 receivers.  Requires: Option 3674G-400.
14.	3674G-405	4-port T type Bias-tees	Four T-type biasing devices are configured internally for the port output DC offset voltage.  Requires: Option 3674G-400 +3674G-401 +3674G-404, 3674G-403 cannot be configured at the same time.
15.	3674G-S30	Spectrum Analysis Function	Used to provide a multichannel spectrum testing function.
16.	3674G-JL	Calibration Services	Provide metrological calibration services and provide metrological reports
17.	3674G-EWT1	Extended warranty for 1 year	Beyond the warranty period, the warranty is extended for 1 year, and the two-year extended warranty is optional for 2 items, and so on

## The 3674H Vector Network Analyzer Option

No.	Model	Name	Function
1.	3674H-003	Noise Figure Measurement	For accurate measurement of S parameters, noise coefficient, and noise parameters. 2-Port Requires: Option 3674H-201 + 3674H-204 4-Port Requires: Option 3674H-401 +3674H- 404. (Note: Two-port electronic calibrators and ordinary noise sources need to be purchased separately.)
2.	3674H-008	Pulse Measurement	For the S parameter measurement in the pulse state, ports 1 and 3 outputs the pulse modulation signal.
3.	3674H-018	Multi-port Device Expansion	For the extended vector network analyzer is 16 ports. Requires: Option 3674H-400 +3674H-404.
4.	3674H-023	Mixer/Converter Measurement	For the mixer-based vector parameter measurement. Requires: Option 3674H-400 +3674H- 404 + 3674-S20.
5.	3674H-201	2-port Programmable Step Attenuator	Configure 2-60dB step attenuators for source path and 2-35dB step attenuators for receiver path. Requires: Option 3674H-204.
6.	3674H-203	2-port Low-frequency Expansion	The lower frequency range can be extended to 500Hz. Requires: Option 3674H-204, 3674H-205 cannot be configured at the same time.
7.	3674H-204	Configurable Test Set	Expand the test device of the two-port model, add the panel jumper, and can use A, B, R1, R2 receiver independently.
8.	3674H-205	2-port T-type Bias-tees	Two T-type biasing devices are configured internally

			for the port output DC offset voltage.  Requires: Option 3674H-201 +3674H-204, 3674H-203 cannot be configured at the same time.
9.	3674H-400	4-port measurement	Dual-source excitation four-port vector network analyzer configuration with a frequency range of 10 MHz to 50 GHz.
10.	3674H-401	4-port programmable Step Attenuator	Install 4-60dB step attenuators for source path and 4-35dB step attenuators for receiver path.  Requires: Option 3674H-400+3674H- 404.
11.	3674H-402	Active Intermodulation Distortion Measurement	For active intermodulation distortion signal measurement. Requires: Option 3674H-400 + 3674H-404 + 3674-S20.
12.	3674H-403	4-port 500Hz low-frequency expansion	The lower frequency range can be extended to 500Hz. Requires: Option 3674H-400 + 3674H-404, 3674H-405 cannot be configured at the same time.
13.	3674H-404	Configurable Test Set	Expand the test device of the four-port model, add the panel jumper, and can independently use A, B, C, D, R1, R2, R3, R4 receivers.  Requires: Option 3674H-400.
14.	3674H-405	4-port T type Bias-tees	Four T-type biasing devices are configured internally for the port output DC offset voltage.  Requires: Option 3674H-400 + 3674H-401 + 3674H-404.  3674H-403 cannot be configured at the same time.
15.	3674H-S30	Spectrum Analysis Function	Used to provide a multichannel spectrum testing function.
16.	3674H-JL	Calibration Services	Provide metrological calibration services and

			provide metrological reports
17.	3674H-EWT1	Extended warranty for 1 year	Beyond the warranty period, the warranty is extended for 1 year, and the two-year extended warranty is optional for 2 items, and so on

### The 3674K Vector Network Analyzer Option

No.	Model	Name	Function
1.	3674K-008	Pulse Measurement	For the S parameter measurement in the pulse state, ports 1 and 3 output the pulse modulation signal.
2.	3674K-018	Multi-port Expansion Device	For the extended vector network analyzer is 16 port. Requires: Option 3674K- 400 + 3674K-404.
3.	3674K-023	Mixer/Converter Vector Measurement	For the mixer-based vector parameter measurement. Requires: Option 3674K-400 + 3674K-404 + 3674-S20.
4.	3674K-201	2-port Programmable Step Attenuator	2-50dB programmed step attenuators for source path and 2-50dB programmed step attenuators for receiver path. Requires: Option 3674K-204.
5.	3674K-203	2-port 500Hz Low-frequency Expansion	The lower frequency range can be extended to 500Hz. Requires: Option 3674K-204, 3674K-205 cannot be configured at the same time.
6.	3674K-204	Configurable Test Set	Expand the test device of the two-port model, add the panel jumper, and can use A, B, R1, R2 receiver independently.
7.	3674K-205	2-port T-type Bias-tees	Two T-type biasing devices are configured internally for the port output DC offset voltage.

			Requires: Option 3674K-201 + 3674K-204, 3674K-203 cannot be configured at the same time.
8.	3674K-400	4-port measurement	Dual-source excitation four-port vector network analyzer configuration with a frequency range of 10 MHz to 53 GHz.
9.	3674K-401	4-port programmable Step Attenuator	4-50dB programmed step attenuators for source path and 4-50dB programmed step attenuators for receiver path.  Requires: Option 3674K- 400 +3674K- 404.
10.	3674K-402	Active Intermodulation Distortion Measurement	For active intermodulation distortion signal measurement. Requires: Option 3674K- 400 +3674K- 404 +3674- S20.
11.	3674K-403	4-port 500Hz low-frequency expansion	The lower frequency range can be extended to 500Hz. Requires: Option 3674K-400+3674K-404, 3674K-405 cannot be configured at the same time.
12.	3674K-404	Configurable Test Set	Expand the test device of the four-port model, add the panel jumper, and can independently use A, B, C, D, R1, R2, R3, R4 receivers.  Requires: Option 3674K-400.
13.	3674K-405	4-port T type Bias-tees	Four T-type biasing devices are configured internally for the port output DC offset voltage.  Requires: Option 3674K-400+3674K-401 +3674K-404, 3674H-403 cannot be configured at the same time.
14.	3674K-S30	Spectrum Analysis Function	Used to provide a multichannel spectrum testing function.
15.	3674K-JL	Calibration Services	Provide metrological calibration services and provide

			metrological reports
16.	3674K-EWT1	Extended warranty for 1 year	Beyond the warranty period, the warranty is extended for 1 year, and the two-year extended warranty is optional for 2 items, and so on

### The 3674L Vector Network Analyzer Option

No.	Model	Name	Function
1.	3674L-008	Pulse Measurement	For the S parameter measurement in the pulse state, ports 1 and 3 output the pulse modulation signal.
2.	3674L-018	Multi-port Expansion Device	For the extended vector network analyzer is 16 port. Requires: Option 3674L- 400 +3674L- 404.
3.	3674L-023	Mixer/Converter Vector Measurement	For the mixer-based vector parameter measurement. Requires: Option 3674L-400 +3674KL-404 +3674-S20.
4.	3674L-201	2-port Programmable Step Attenuator	2-50dB programmed step attenuators for source path and 2-50dB programmed step attenuators for receiver path. Requires: Option 3674L-204.
5.	3674L-203	2-port 500Hz Low-frequency Expansion	The lower frequency range can be extended to 500Hz. Requires: Option 3674L-204,3674L-205 cannot be configured at the same time.
6.	3674L-204	Configurable Test Set	Expand the test device of the two-port model, add the panel jumper, and can use A, B, R1, R2 receiver independently.
7.	3674L-205	2-port T-type Bias-tees	Two T-type biasing devices are configured internally for the port output DC offset voltage. Requires: Option 3674L-201 + 3674L-204, 3674L-203 cannot be configured at the same time.

8.	3674L-400	4-port measurement	Dual-source excitation four-port vector network analyzer configuration with a frequency range of 10 MHz to 67 GHz.
9.	3674L-401	4-port programmable Step Attenuator	4-50dB programmed step attenuators for source path and 4-50dB programmed step attenuators for receiver path. Requires: Option 3674L-400 + 3674L-404.
10.	3674L-402	Active Intermodulation Distortion Measurement	For active intermodulation distortion signal measurement. Requires: Option 3674L-400 +3674L-404 + 3674-S20.
11.	3674L-403	4-port 500Hz low-frequency expansion	The lower frequency range can be extended to 500Hz. Requires: Option 3674L-400 +3674L-404, 3674L-405 cannot be configured at the same time.
12.	3674L-404	Configurable Test Set	Expand the test device of the four-port model, add the panel jumper, and can independently use A, B, C, D, R1, R2, R3, R4 receivers. Requires: Option 3674L-400.
13.	3674L-405	4-port T type Bias-tees	Four T-type biasing devices are configured internally for the port output DC offset voltage. Requires: Option 3674L-400 + 3674L-401 + 3674L-404, 3674L-403 cannot be configured at the same time.
14.	3674L-S30	Spectrum Analysis Function	Used to provide a multichannel spectrum testing function.
15.	3674L-JL	Calibration Services	Provide metrological calibration services and provide metrological reports

### The 3674N Vector Network Analyzer Option

No.	Model	Name	Function
1.	3674N-400	4-port Measurement Option	Dual source excitation four-port vector network analyzer configuration with frequency range 10 MHz to 90 GHz.
2.	3674N-EWT1	Extended warranty for 1 year	Beyond the warranty period, the warranty is extended for 1 year, and the two-year extended warranty is optional for 2 items, and so on

### The 3674P Vector Network Analyzer Option

No.	Model	Name	Function
1.	3674P-EWT1	Extended warranty for 1 year	Beyond the warranty period, the warranty is extended for 1 year, and the two-year extended warranty is optional for 2 items, and so on